

SKIPPER

Dual Channel Graphic Depth Sounder (10 - 265 kHz)

GDS102

Operation and Installation Manual



SKIPPER Electronics AS Telephone:
Enebakkveien 150
P. O. Box 151, Manglerud
0612 Oslo, Norway
www.skipper.no

+47 23 30 22 70
Telefax: +47 23 30 22 71
E-mail: support@skipper.no
Co. reg. no:NO-965378847-MVA

Document no: **DM-G002-SB**
Rev: 1414A
For software rev: 1.12.07 - 1.12.10
Edition: 2015-06-19

IMPORTANT

When doing service or repair, please wait two minutes after power off, before unplugging internal connectors.

Weitergabe sowie vervielfältigung dieser unterlage, verwertung und mitteilung ihres inhaltes nicht gestattet, soweit nicht ausdrücklich zugestanden. Zuwiderhandlungen verpflichten zu schadenersatz.

Toute communication ou reproduction de ce document, toute exploitation ou communication de ou son contenu sont interdites, sauf autorisation expresse. Tout manquement à cette règle est illicite et expose son auteur au versement de dommages et intérêts.

Copying of this document, and giving it to others and the use or communication of contents thereof, are forbidden without express authority. Offenders are liable to the payment of damages.

Sin nuestra expresa autorización, queda terminantemente prohibida la reproducción total o parcial de este documento, así como su uso Indebido y/o su exhibición o comunicación a terceros. De los infractores Se exigirá el correspondiente resarcimiento de daños y perjuicios.

Contents

1. INTRODUCTION.....	6
System Summary	6
Transducers	6
Primary/Secondary Channels Concept	6
Operator Panel and Data Entry	6
Recorded Data Storage	7
Fig. 1.1 Operator Unit Panel Layout.....	7
Fig. 1.2. System Diagram	8
Interfacing	9
Outputs	9
Inputs.....	9
Alarms.....	9
Additional Features	9
Auto Range.....	9
External Printer	9
Options	9
Remote Sounding Control.....	10
Sound Speed Calibration.....	10
2 OPERATION.....	11
Parameter entry	11
Fig. 2.1. Setting and Parameter Entry Flowchart.....	11
Operation Screens	12
Primary Operation Screens (screen 1 - 3).....	13
Fig. 2.2. Screen 1. Gain, TVG and alarm settings.....	13
Fig. 2.3. Screen 2. Display and print settings.....	14
Fig. 2.4. Screen 3. Power adjustment and options.....	15
Secondary Operation Screens (screen 4 - 12).....	16
Fig. 2.5. Screen 4. Transducer details.....	16
Fig. 2.6. Screen 5. Calendar and clock setting.....	17
Fig. 2.7. Screen 6. Units of measurement.....	18
Fig. 2.8. Screen 7. Interface setup screen.....	19
Fig. 2.9. Screen 8. Recordings selection and play back.....	20
Fig. 2.10. Screen 9. Recordings options.....	21
Fig. 2.11. Screen 10. NMEA control screen.....	22
Fig. 2.12. Screen 11. System status screen.....	23
Fig. 2.13. Screen 12. Oscilloscope screen.....	24
Principal Functions.....	26
Depth Range.....	26
Picture Speed.....	26
Brightness (backlight) adjustment.....	27
Day/Night.....	27
Gain and TVG (Time Variable Gain).....	27
Digital indication.....	27
Frequency.....	27
Output Power	27
Draught and Offset.....	27
External Printer Operation	28
Alarm settings and acknowledgment.....	29
Clock and Calendar Settings.....	29
Data Logging (Recordings Memory).....	29
System ON/OFF.....	29
Simulator.....	30

Status Screen30
 Oscilloscope Screen30
 Nonvolatile Parameter Memory30
 Data type30
 Basic Algorithm Considerations 30
 Bottom detection30
 Ping to Ping filtering30

3. INSTALLATION31

Standard System Supply 31
 Transducer Installation..... 31
 Single transducer location31
 Dual transducer location (fore/aft).....31
 Fig. 3.1. Basic System Configuration.....32
 Dual transducer installation(fore/fore).....32
 Installation Details32
 Transducer Junction Box 33
 Fig. 3.2. Transducer junction box.....33
 Operator Unit Installation 34
 115/230 V selection on Combo Terminal board inside Display Unit.....34
 Fig 3.3. Operator unit.....35
 Fig. 3.4. AC Voltage selection and fuses.....36
 Voltage selection connectors and fuses, Terminal Board36
 External Interface Ports37
 Fig. 3.5. Data Communication Interfaces.37
 Fig. 3.6. Data Communication Interfaces.38
 Fig. 3.7. Back-up battery jumper JP200, on I/O board.39
 Interfacing 40
 NMEA interface40
 Alarm relay.....40
 Analogue interfaces.....40
 Transmitter trigger pulse and bottom pulse outputs41
 External alarm reset input41
 External printer connection41
 Repeaters/Slaves41
 Remote Keyboard.....42
 Remote Sounding Control.....42
 Optocoupler 2 output.....42
 EMC42
 Terminal board connections 43
 Fig. 3.8. Terminal board connections.....43
 Input/Output Circuitry 1 44
 Fig. 3.9. Input/Output Circuitry 144
 Input/Output Circuitry 2 45
 Fig. 3.10. Input/Output Circuitry 245
 Input/Output Circuitry 3 46
 Fig. 3.11. Input/Output Circuitry 346

4. START-UP AND SYSTEM ADAPTION.....47

System Adaptation 47
 Primary channel assignment47
 Transducer installation position47
 Screen presentation47
 Alarm limits and local alarm buzzer control.....47
 Analogue Outputs Range Selection47
 Clock and calendar settings.....47
 Language and Units of Measurement48

NMEA Setup	48
NMEA transmitted/output messages	48
NMEA received/input messages	49
Fig. 4.1. NMEA connector XJ402.....	49
Filter setup.....	50
Fig. 4.3. SW1 bandwidth settings	50
Fig. 4.2. Frequency settings	50
Frequency setup	50
Options.....	57
Calibration, sound speed	57
Remote Sounding Control.....	57
Ping	57
5. TROUBLE SHOOTING	58
High voltage measurement.....	58
Fig. 5.1. Function LEDs, on terminal board.....	59
Function LEDs.....	59
Typical Status Screen 11 Contents.....	60
6. USER MAINTENANCE	63
Transducer maintenance	63
Operator Unit Maintenance.....	63
7. SYSTEM SPECIFICATIONS	64
Functional Properties	64
Performance	64
Transducer and Junction Box.....	65
Operator Unit Cabinet.....	65
Dimensions	66
8. SERVICE.....	67
CPU 6742VE Setup	68
Master Reset Procedure.....	69
Upgrading Software	69
9. EMC MOUNTING KIT	70
10. WARRANTY AND UTILIZATION	71
Warranty:.....	71
Utilization:	71
11. NOTES	72
12. INDEX.....	73

1. Introduction

System Summary

GDS102 is a dual channel navigation sounder with a large colour LCD. The echo sounder graphics is continuously shown on the LCD along with complete navigational details. It is possible to connect an external printer to the operator unit. The sounder contains a Compact Flash which keeps 24 hours of recorded information. Depth, time and all available navigation data are stored continuously so that the last 24 hours of information is always available. All this information may also be printed on the external printer. All IMO (International Maritime Organization) requirements are met or exceeded. Comprehensive interfaces are available including NMEA 0183 inputs and outputs.

Transducers

GDS102 is prepared for connection of 1 or 2 transducers with a resonant frequency in the range of 10 - 265 kHz. Transmitter stage of the transceiver PCB is tuned to impedance of 100 Ohm, so the transducer type (if not supplied by SKIPPER) should be selected accordingly. Channel 1 is optimized for higher frequencies (50 - 265 kHz), while channel 2 is for a lower frequency range (10 - 50 kHz). The operating frequencies for both channels are preset in production to 50 kHz (ch 1) and 200 kHz (ch 2) or to customer specification. The frequencies can be changed with DIP switches on the transceiver PCB, if necessary. See "[Frequency setup](#)" [on page 50](#) for further instructions.

Primary/Secondary Channels Concept

In order to avoid confusion if two transducers are used simultaneously, one of the channels is assigned as primary, the other one - secondary. Assignment of these is programmable by the user, see "[Fig. 2.5. Screen 4. Transducer details.](#)" [on page 16](#).

Data from the primary channel will always be used to set analogue outputs and in the NMEA standard sentences. **Note:** If SKIPPER proprietary message is enabled, the depth information from both channels will be provided and can be recognized by NMEA listeners. See "[NMEA Setup](#)" [on page 48](#) for further details about SKIPPER PSKPDPT format.

It is advisable, that the channel which has a transducer with better installation and performance conditions is assigned as primary. In most cases that would be the channel with a transducer installed forward. It is also important that the primary channel is set to an IMO approved transducer for the whole system to be approved. See "[Primary channel assignment](#)" [on page 47](#).

Operator Panel and Data Entry

The operator unit contains a colour LCD, a keyboard with fixed keys, soft keys and a rotating encoder. The function of each soft key depends on the active screen. The buttons are labeled on the lower rim of the LCD. Several screens are used to enter various settings and calibration parameters. Each screen has a selection of soft key buttons. Screens 1 through 3 are primary operation screens with appropriate operator controls. Screens 4 through 12 are calibration, setup and system supervision screens. The various screens will be described in detail later.

The LCD is backlit, and backlight intensity may be adjusted by the user. Day or night vision modes can be selected according to the ambient light conditions. The echogram is normally displayed continuously on the LCD. An optional external printer can be connected, if hardcopy documentation is required. The operator unit is normally flush mounted.

Recorded Data Storage

Depth and other navigational data are continuously stored for 24 hours in non-volatile memory (Compact Flash). See [“Data Logging \(Recordings Memory\)” on page 29](#). A HP Deskjet printer or Epson D88 printer with Centronics (parallel) interface may be connected for a paper copy, (ask SKIPPER for printer specification). Alternatively an Epson LQ-300+ printer for continuous paper feed may be used. Printer is only required when hard copy documentation is necessary.

Warning

False bottom echoes may occur when:

- The bottom is out of range.
- Extreme noise conditions are present.
- Bottom signal may be lost for other reasons, like wakes, or aeration below transducer.

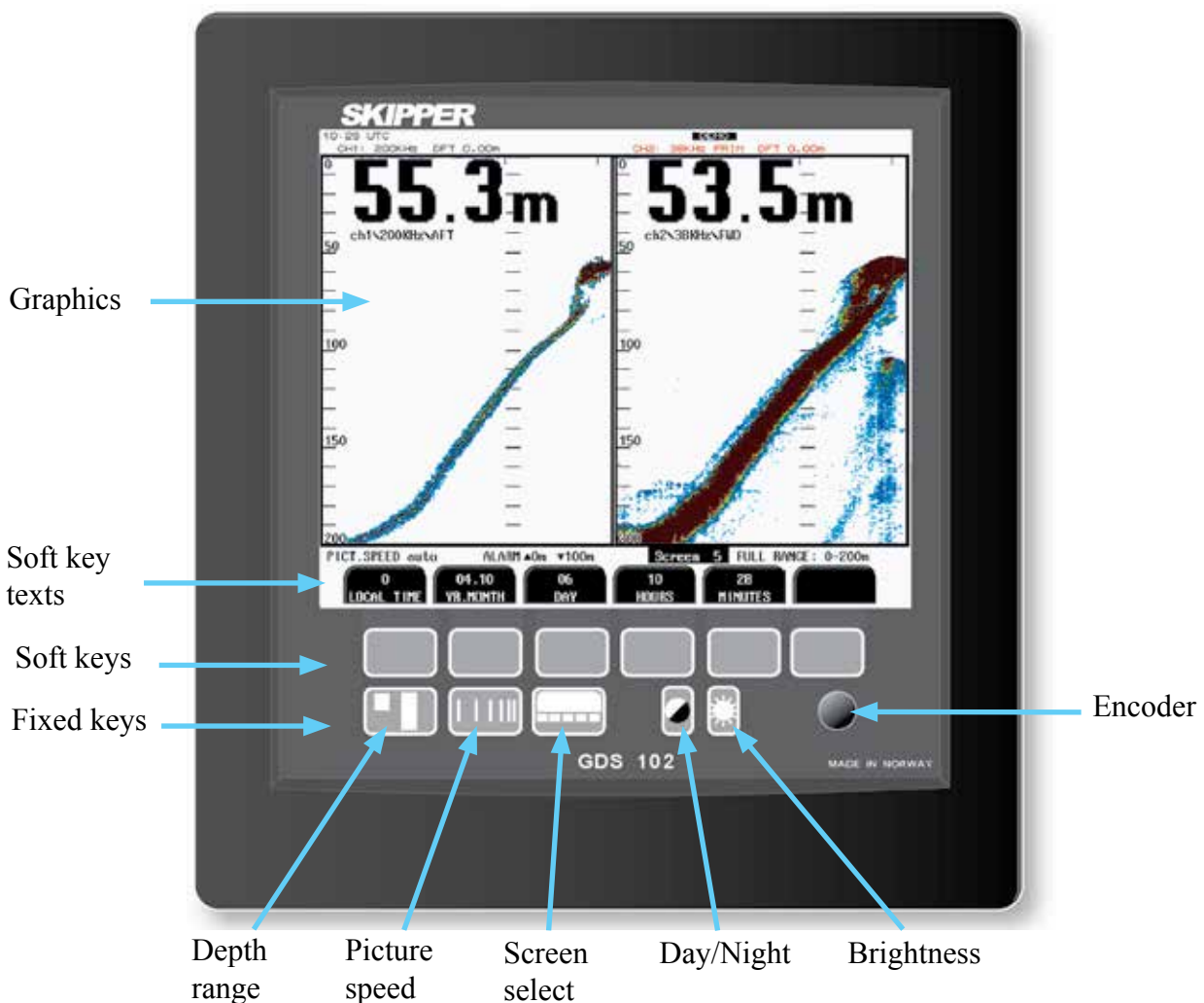

Fig. 1.1 Operator Unit Panel Layout

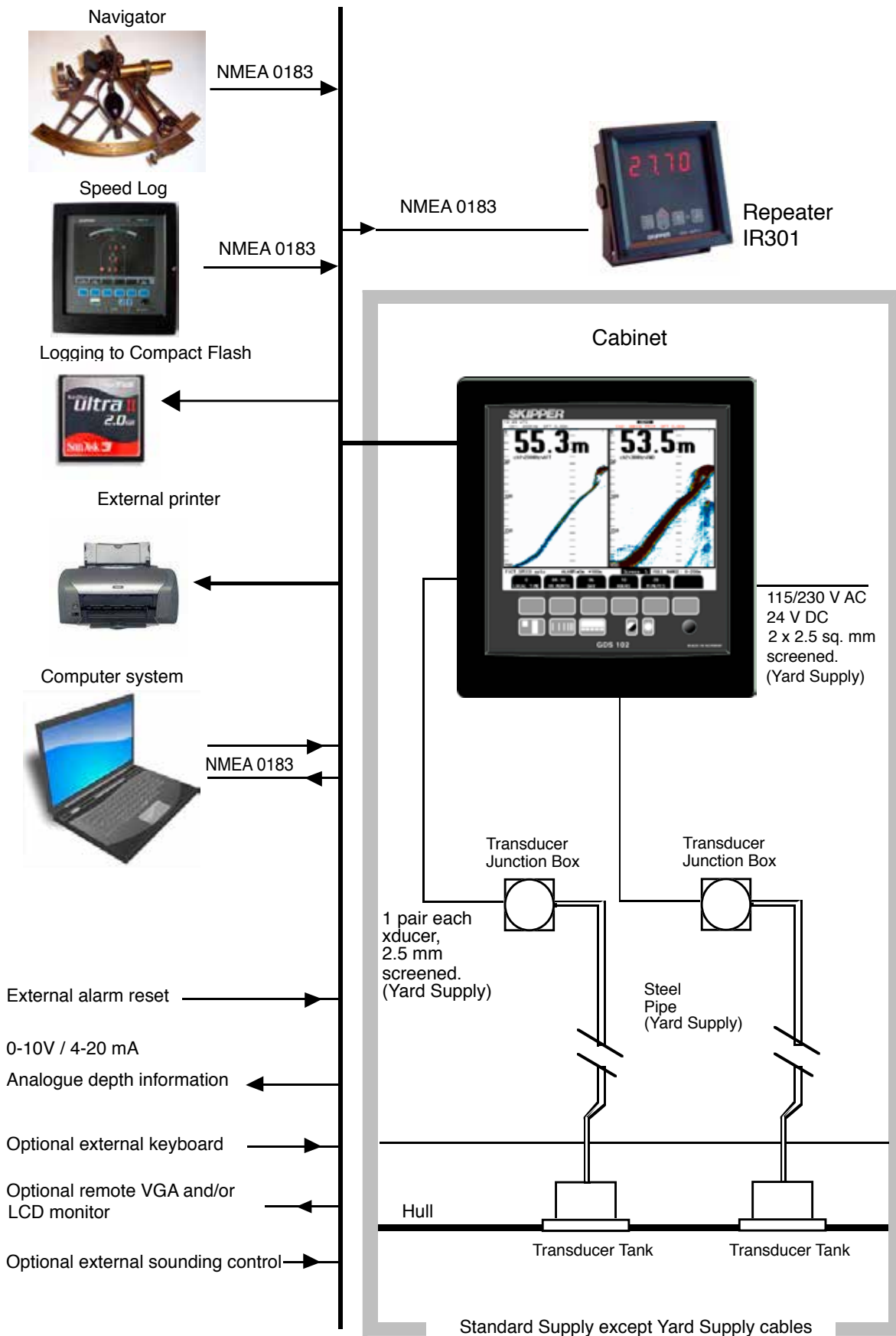

Fig. 1.2. System Diagram

Interfacing

The GDS102 has various interface possibilities.

Outputs

- Transmitter trigger pulse and bottom pulse outputs. See [“Transmitter trigger pulse and bottom pulse outputs” on page 41.](#)
- Analogue outputs 0 - 10 V and 4 - 20 mA. See [“Analogue interfaces” on page 40.](#)
- NMEA 0183 interface outputs of depth information. See [“NMEA interface” on page 40](#) and [“NMEA Setup” on page 48.](#)
- External alarm relay output. See [“Alarm relay” on page 40.](#)
- System malfunction optocoupler output.
- External printer and monitor. See [“External Interface Ports” on page 37.](#)

Inputs

- NMEA 0183 interface input of position, heading, speed and UTC (Coordinated Universal Time). See [“NMEA Setup” on page 48.](#)
- External alarm reset. See [“External alarm reset input” on page 41](#) and [“Input/Output Circuitry 3” on page 46.](#)
- External control and synchronization of transmitter (optional). See [“Remote Sounding Control” on page 57.](#)

Alarms

Shallow and deep water alarms may be adjusted on screen 1. See [“Fig. 2.2. Screen 1. Gain, TVG and alarm settings.” on page 13.](#) A relay output is provided in GDS102 for interface to external alarm systems. At local alarm conditions, an audible alarm is also provided, see [“Fig. 2.12. Screen 11. System status screen.” on page 23.](#)

Additional Features

In addition to the features demanded by the IMO regulations, the following features are available:

Repeaters/Slaves

Graphic CRT or LCD display or digital depth slave repeaters may be connected to the system.

Auto Range

This feature will automatically adjust the depth range to maintain the bottom contour within the middle half of the screen height, and is accessible on screen 3. See [“Fig. 2.4. Screen 3. Power adjustment and options.” on page 15.](#)

External Printer

Printer for endless paper or inkjet printer for single sheets (ask SKIPPER for available types) may be connected for hardcopy requirements.

Options

- Remote keyboard.
- Permanent reduction of output power for adaption to various transducers.

Non-standard features, available as options, which are not approved for normal use for navigation by IMO (contact SKIPPER for more information) include:

Remote Sounding Control

This option lets the GDS102 being controlled remotely in continuous/edge/level/single (manual) ping modes. It can be useful in case of multiple hydroacoustic installations to avoid interference between different systems. If installed, this option is accessible on screen 3. See [“Fig. 2.4. Screen 3. Power adjustment and options.” on page 15.](#)

Sound Speed Calibration

This option will enable adjustment of the sound speed value used for the depth calculations. The standard value is 1500 m/s, but the user may set values from 1400 to 1550 m/s to accommodate accurate propagation speed in known water conditions. If installed, this option is accessible on screen 3. See [“Fig. 2.4. Screen 3. Power adjustment and options.” on page 15.](#)

2 Operation

When the installation is complete, and power is connected to the operator unit, the system is switched on-off by a power switch inside the cabinet. See “[Fig. 3.4. AC Voltage selection and fuses.](#)” on page 36.

Parameter entry

The fixed function buttons, the soft key buttons and the rotating encoder allow the user to adjust the parameters, setpoints and other data. The following flowchart illustrates the procedure for changing settings and entering data. The various screens are shown in detail later.

Example of parameter entry

Suppose you want to enter a value of 800 m for the depth range. The present setting is 100 m. Press the DEPTH RANGE button and keep it pressed while you turn the encoder clockwise. Observe the depth range increase to 800 m, let go of the encoder and release the DEPTH RANGE button. You could also have started from the standard value 1000 m and decreased to 800 m by turning the encoder counter-clockwise.

Buttons with less than 6 possible states or values can be operated without using the encoder at all. The setup will be remembered when the unit is turned off.

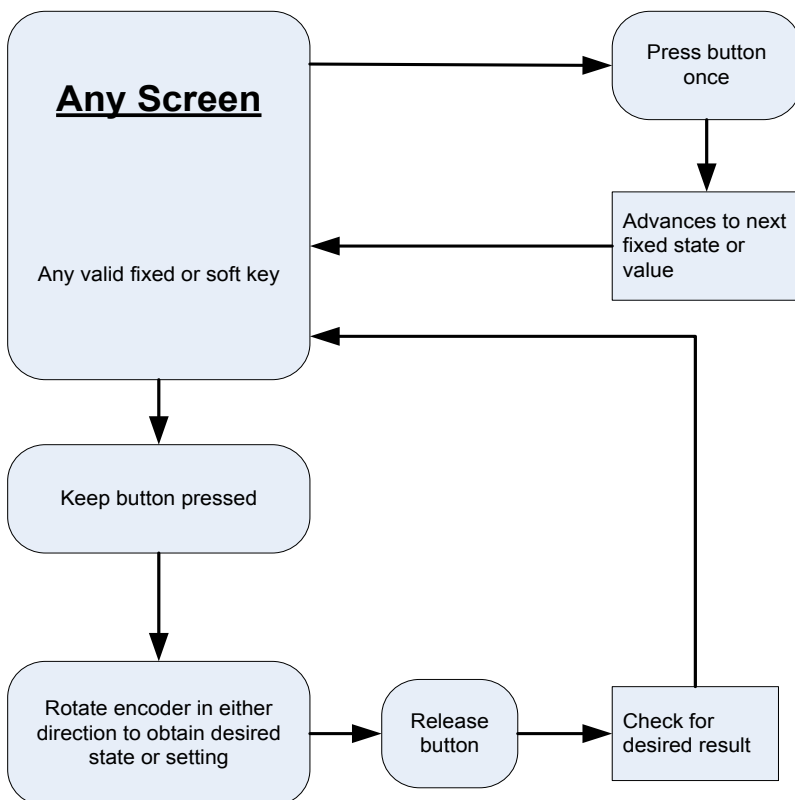

Fig. 2.1. Setting and Parameter Entry Flowchart

Operation Screens

Each of the operation screens contains a graphic picture and a selection of up to 6 soft key buttons. The various screens are selected by keeping the SCREENS button pressed and rotating the encoder in either direction. Turning the encoder clockwise cycle the screens in the sequence 1 to 12, and counter clockwise rotation cycles the screens in the sequence 12 to 1. Screens 1, 2 and 3, covering the primary functions, may also be cycled by repeatedly pressing the SCREENS button.

The screen layouts are outlined in fig. 2.2 through 2.13. The various soft key functions are described with each screen.

Note: Some of the soft keys on the following pages appear “dimmed”. The reason for this, is that the screen shots are taken in “demo” mode.

Note: The primary and secondary channels frequencies are indicated at the top of the screens along with draught settings regardless of the selected screen and graphic screen layout. PRIMARY channel information is marked by blue colour. (See below).

Time indication manual or from GPS Primary channel indication Position from GPS Draught indication Speed indication from GPS Heading indication from GPS Draught indication Depth type indication

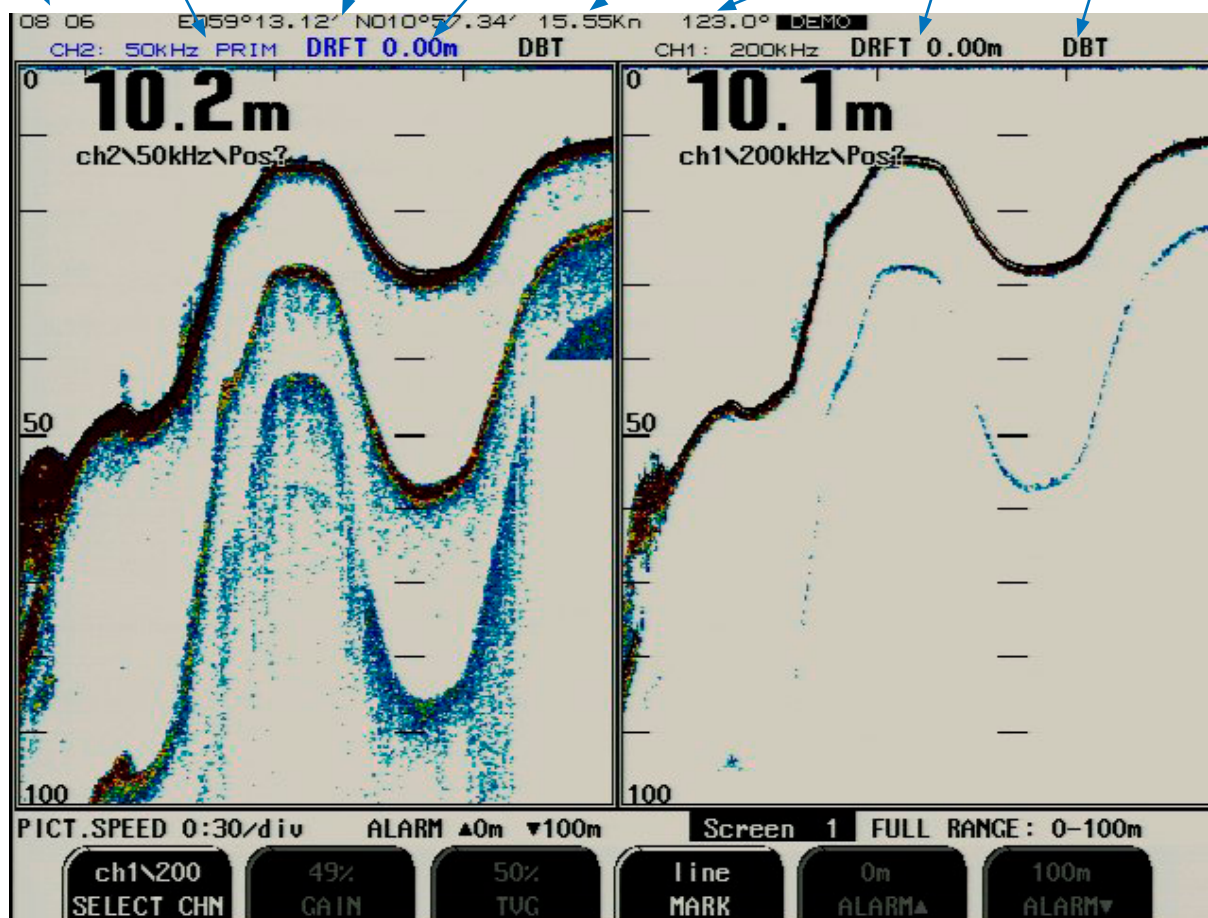

Primary Operation Screens (screen 1 - 3)

The following figures show the operation of the primary operation screens. Some of the soft keys are self explanatory. Refer to the corresponding chapter in “Principal Functions” for more information about particular features. See [“Principal Functions.” on page 26.](#)

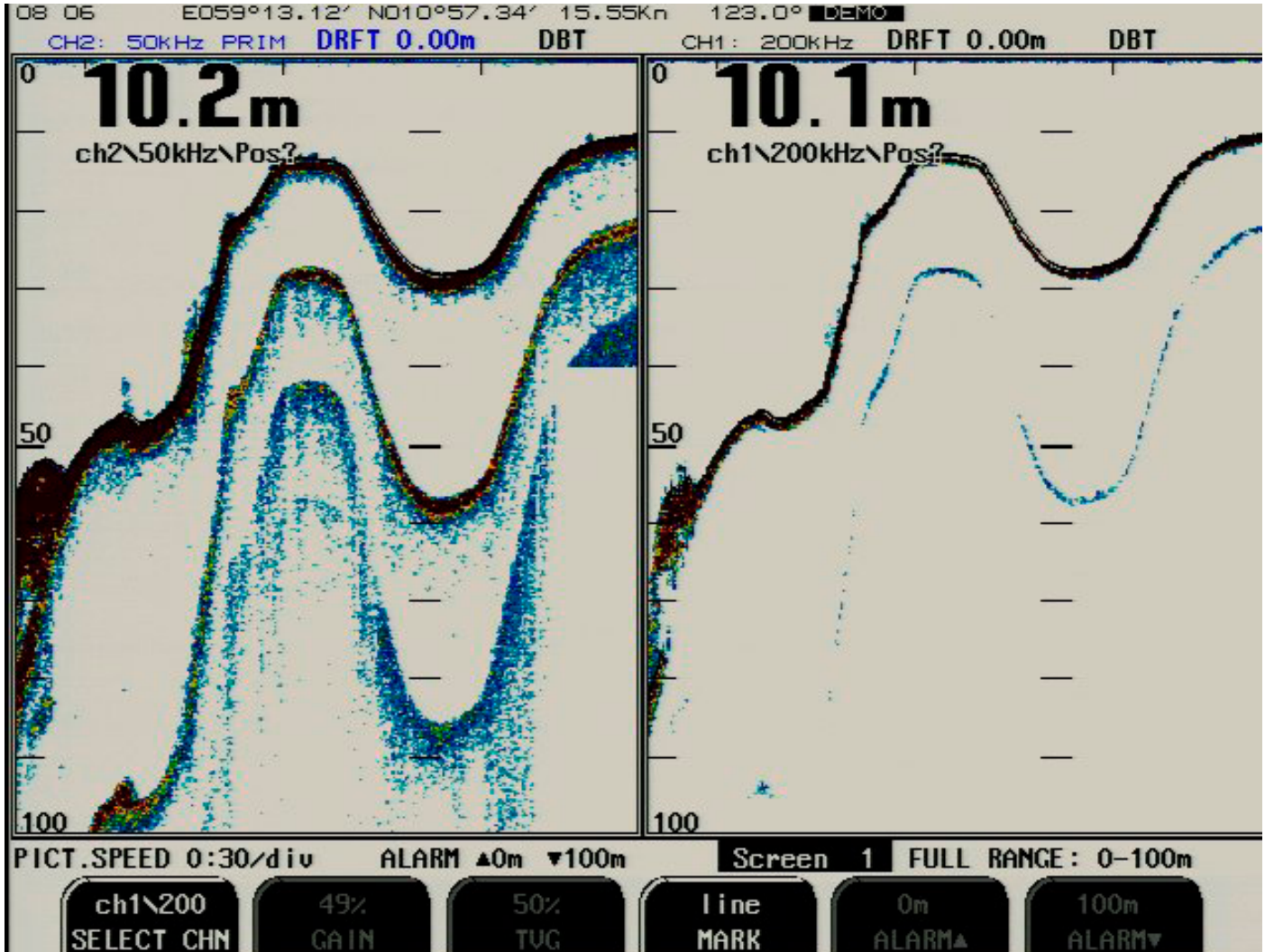

Fig. 2.2. Screen 1. Gain, TVG and alarm settings.

Soft key	Name	Range/ value	Default value	Description
1	SELECT CHN	Ch1 / Ch2	Ch 2	Selected channel enables adjustment of GAIN and TVG. The frequency of the channel is displayed next to the channel number.
2	GAIN	0 - 100 %	Ch1: 55% Ch2: 41%	Gain adjustment. (% represents range 1 - 50 dB). See “Gain and TVG (Time Variable Gain)” on page 27 for further details about the gain function.
3	TVG	0 - 100 %	Ch1: 65% Ch2: 60%	Time Variable Gain adjustment. (% represents 10 - 50 dB suppression). See “Gain and TVG (Time Variable Gain)” on page 27 for further details.
4	MARK	Line		Mark line will be provided both on the screen and paper. (If printer is active).
5	ALARM ▲	0 - 99 m	0 m	Shallow water alarm adjustment. See “Alarm limits and local alarm buzzer control” on page 47 for further details about alarm function.
6	ALARM ▼	0 - 5000 m	100 m	Deep water alarm adjustment. See “Alarm limits and local alarm buzzer control” on page 47 further details about alarm function.

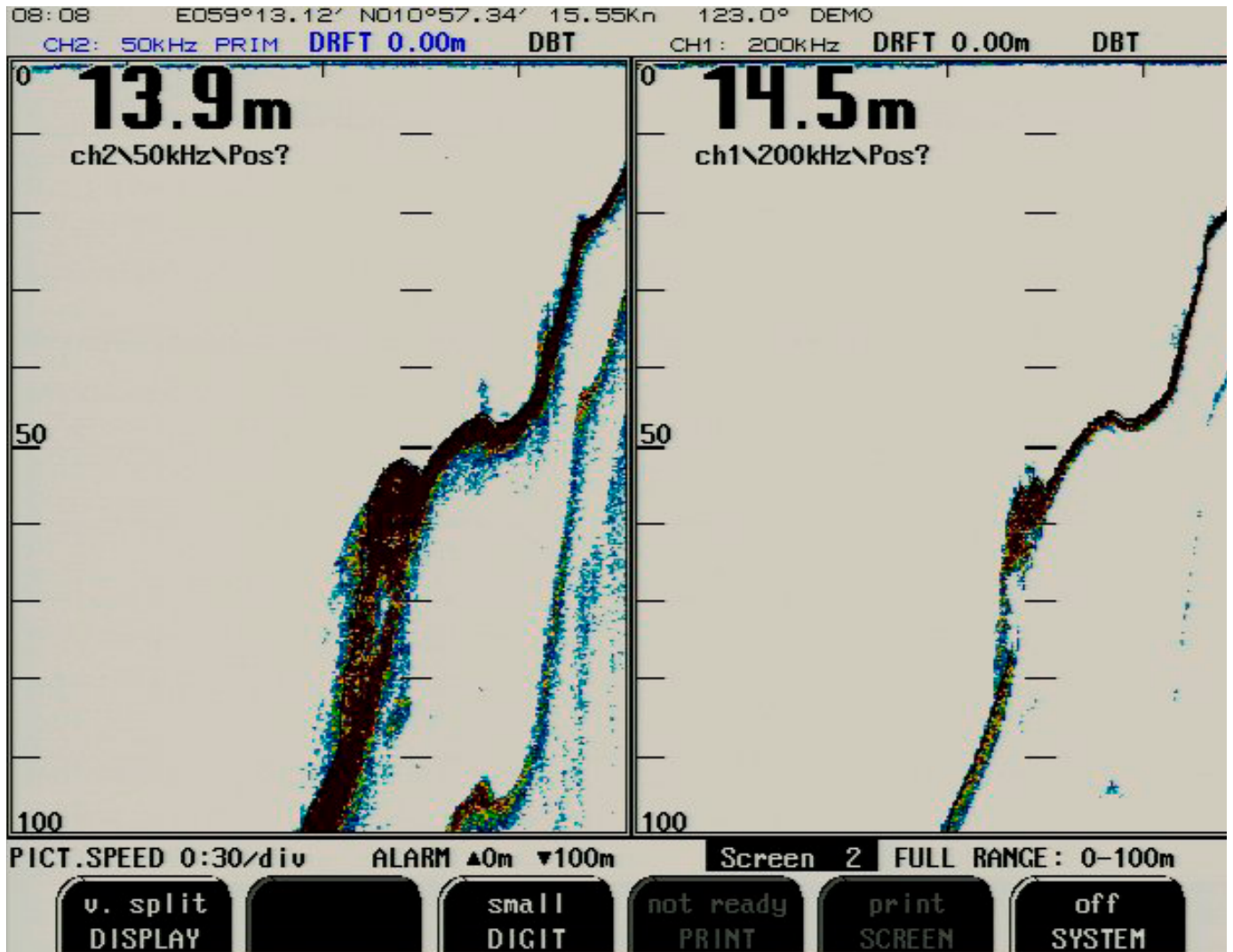

Fig. 2.3. Screen 2. Display and print settings.

Soft key	Name	Range/value	Default value	Description
1	DISPLAY	v.split / h.split /primary freq	v.split	Selection of screen layout (either vertical or horizontal split of the total screen area, only primary transducer). Note: If only one of the channels is being displayed, the other one can still be activated, unless it is disabled by soft key LOCATION at screen 4. See “ Fig. 2.5. Screen 4. Transducer details. ” on page 16.
2				Not used.
3	DIGIT	Small/large	Small	Selection of digital depth indication size.
4	PRINT	Off [not ready] /on	Off	Start and stop of continuous printing. Note: If printer is not connected, this button is “ Dimmed ” and can not be used.
5	SCREEN	Print		Screen hardcopy, can be used for documentation and troubleshooting.
6	SYSTEM	On/off	On	Setting the sounder in standby mode, switching off the major power consuming elements (transmitter, LCD screen etc.) The sounder can be restarted by pressing any button. Note: The unit is still energized!!! Do not perform any re-connections before switching off the mains on the terminal PCB inside the cabinet.

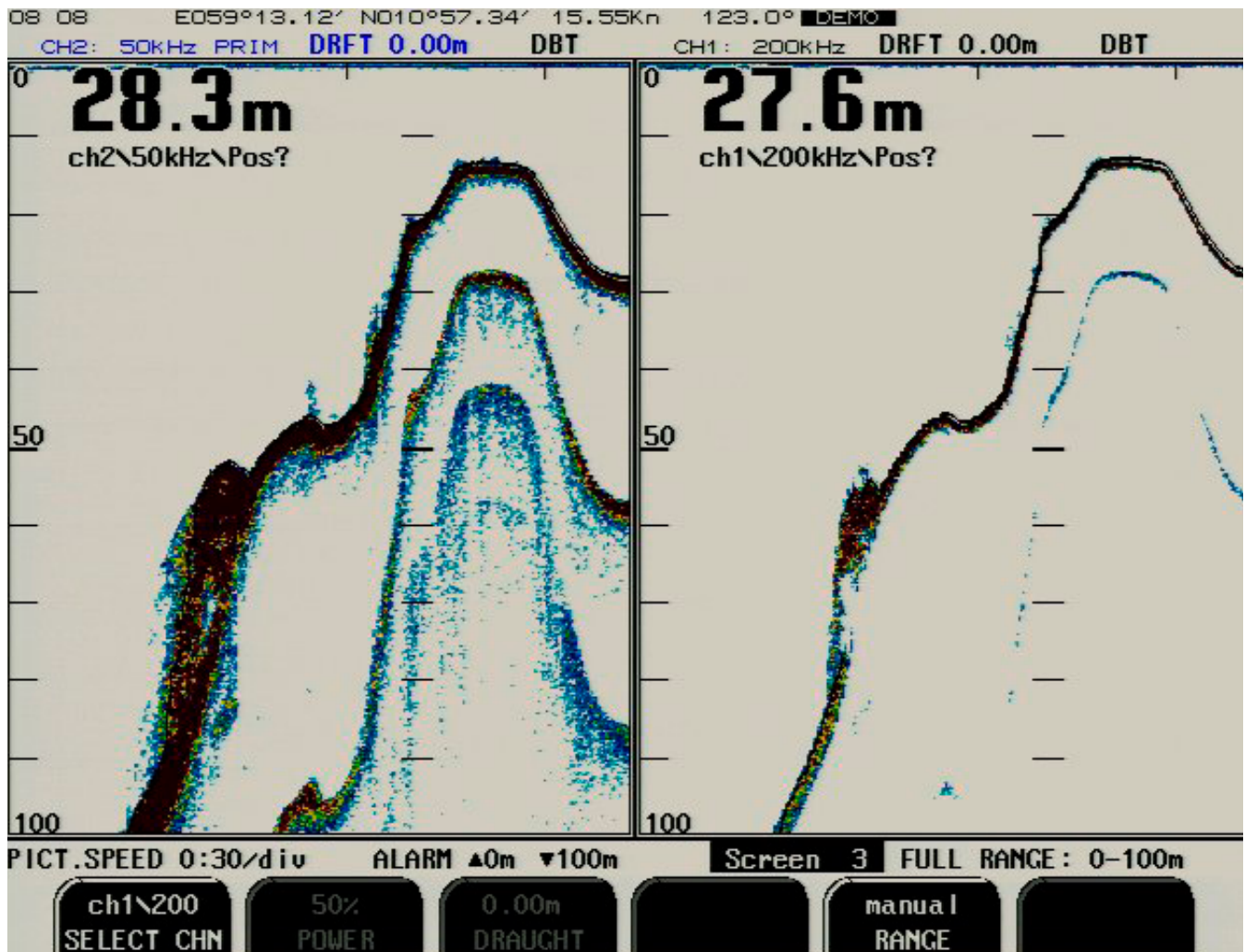

Fig. 2.4. Screen 3. Power adjustment and options.

Soft key	Name	Range/value	Default value	Description
1	SELECT CHN	Ch1/Ch2	Ch 2	Selected channel enables adjustment of POWER, and DRAUGHT. The channel frequency is displayed next to the channel number.
2	POWER	1 - 100 %	50 %	Transmitter power adjustment.
3	DRAUGHT	0.00 to 99.9 m	0.00 m	Draught correction, distance between the lowest point of the vessel (near the transducer) and the water surface. Setting to zero will display the depth from the lowest point. Note: Set individually for both channels. Also see OFFSET on “ Fig. 2.13. Screen 12. Oscilloscope screen. ” on page 24.
4 (optional)	SOUND	1400 - 1550 m/s	1500 m/s	Sound speed setting.
5	RANGE	Manual/autorange	Manual	Automatic range control.
6 (optional)	PING	Continuous/edge/level/manual		External sounding control. Continuous - internal control of the soundings. Edge - external control of the soundings, synchronized with an edge (positive or negative) of the external signal. Level - external control of the soundings, enabling/disabling continuous soundings by the level of the external signal. Manual (Single) - control of the soundings by pressing PICTURE SPEED key.

Secondary Operation Screens (screen 4 - 12)

The following figures show the operation of the secondary operation screens.

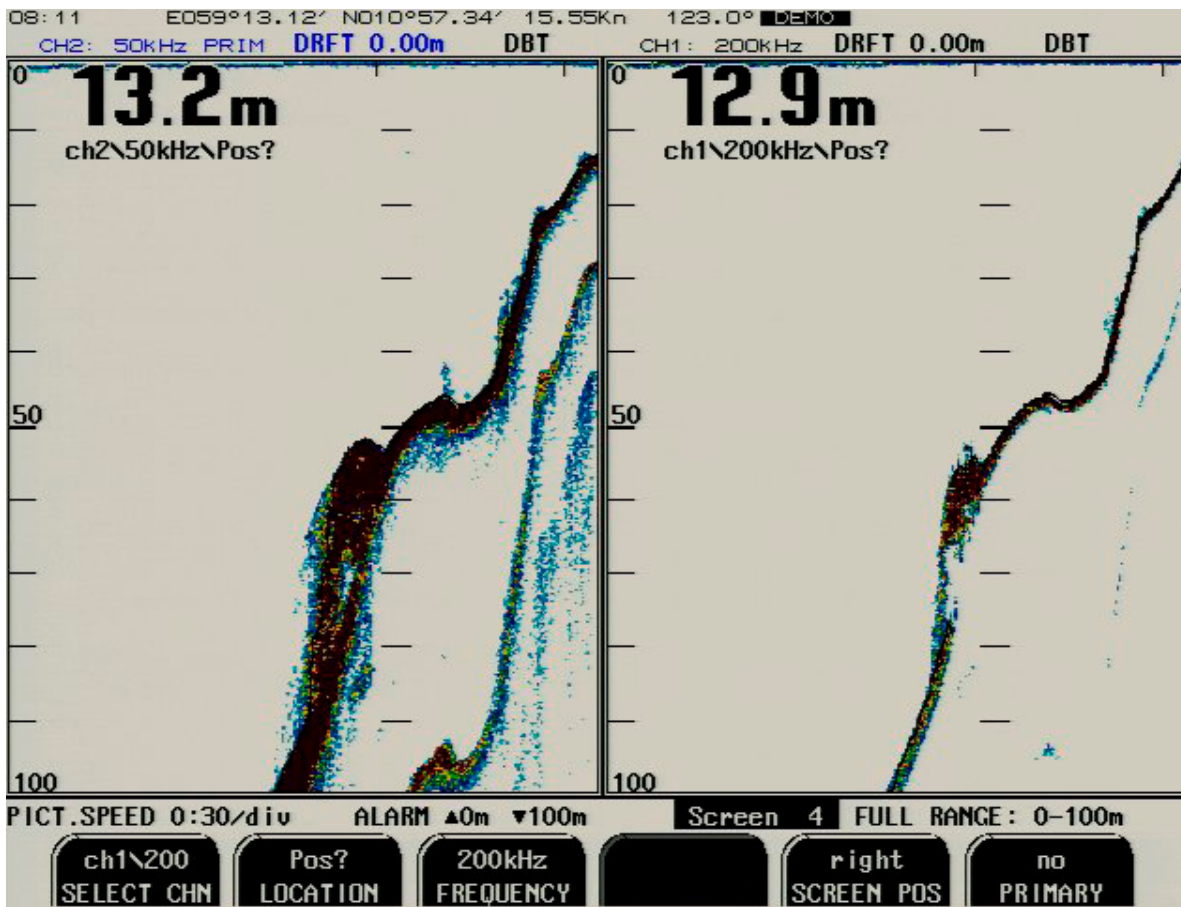

Fig. 2.5. Screen 4. Transducer details.

Soft key	Name	Range/value	Default value	Description
1	SELECT CHN	Ch1/Ch2	Ch 2	Selected channel enables adjustment of LOCATION, FREQUENCY, SCREEN POS, PRIMARY settings, explained below. The frequency of the channel is displayed next to the channel number.
2	LOCATION	FWD/AFT/ PORT/STRB/ not inst./pos?	Pos?	Transducer position. Information is being indicated on the screen for easy reference to the transducer and used in SKIPPER proprietary NMEA sentence. Note: If “not inst” (not installed) is selected, the corresponding channel is not operative and will never be displayed (single channel mode). One channel must always be operative, therefore “not inst” can be selected only for one channel at a time.
3	FREQUENCY	10 - 265 kHz	Ch 1: 200 kHz Ch 2: 50 kHz	Adjustment of the frequency of currently selected channel. Note: The actual frequency of the channels must be programmed by the DIP switches on the transceiver PCB. See “Frequency setup” on page 50 for further instructions.
4				Not used
5	SCREEN POS	(Left/right)/ (upper/lower)	Left	Selects the screen position of graphical window of currently selected channel. (Dependant of v.split/h.split screen 2).
6	PRIMARY	Yes/no	Ch 2	Toggles PRIMARY property of the selected channel. See “Primary channel assignment” on page 47 for details.

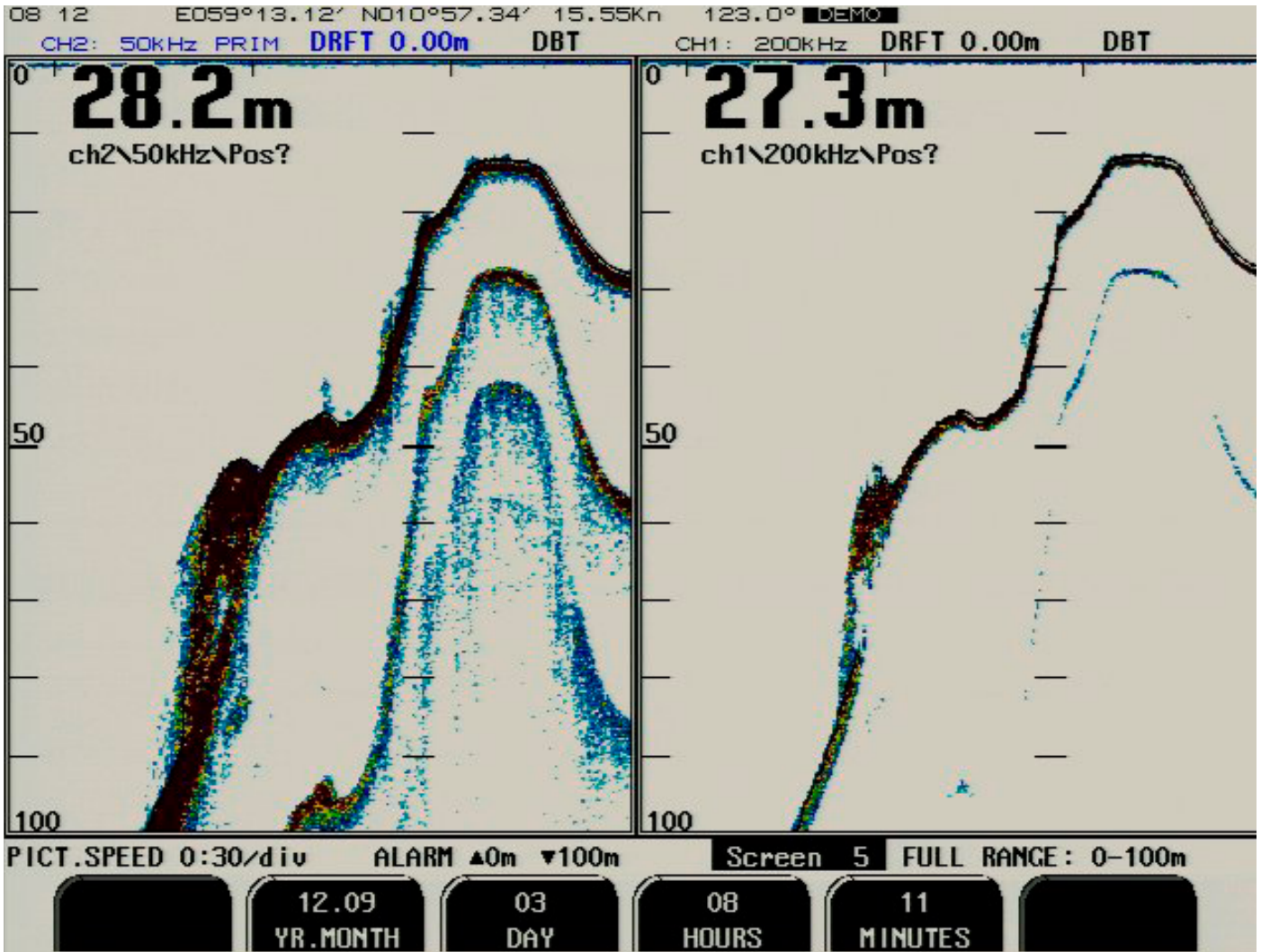

Fig. 2.6. Screen 5. Calendar and clock setting.

Soft key	Name	Range/value	Default value	Description
1				Not used.
2	YR.MONTH	01.04-...		Year and month setting.
3	DAY	1 - 31		Date setting.
4	HOURS	0 - 23		Hours setting.
5	MINUTES	0 - 59		Minutes setting.
6				Not used.

Note: If time and date information is received from external NMEA talker (e.g. GPS), soft keys 2, 3, 4 and 5 are not user adjustable.

Warning: If the clock is adjusted backwards, see [“Fig. 2.10. Screen 9. Recordings options.”](#) on page 21 cleanup records.

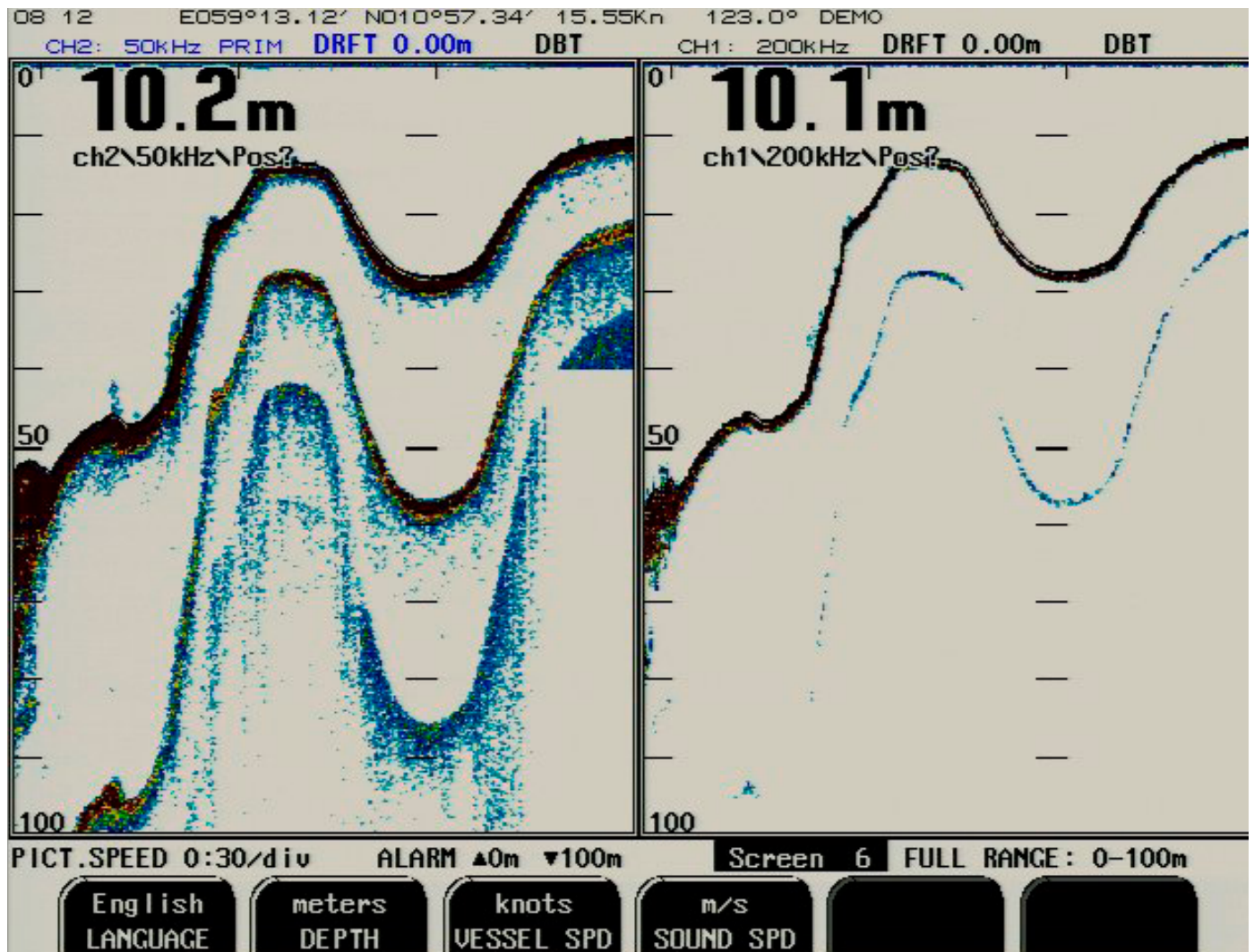

Fig. 2.7. Screen 6. Units of measurement.

Soft key	Name	Range/value	Default value	Description
1	LANGUAGE	English, French, Spanish, German, Norwegian	English	Screen language selection.
2	DEPTH	Meters, feet, fathoms, braccias	Meters	Unit of measurement for depth.
3	VESSEL SPD	Knots, km/h, mi/h	Knots	Unit of measurement for vessel speed.
4	SOUND SPD	m/s, knots, km/h, mi/h, ft/s	m/s	Unit of measurement for sound speed.
5				Not used.
6				Not used.

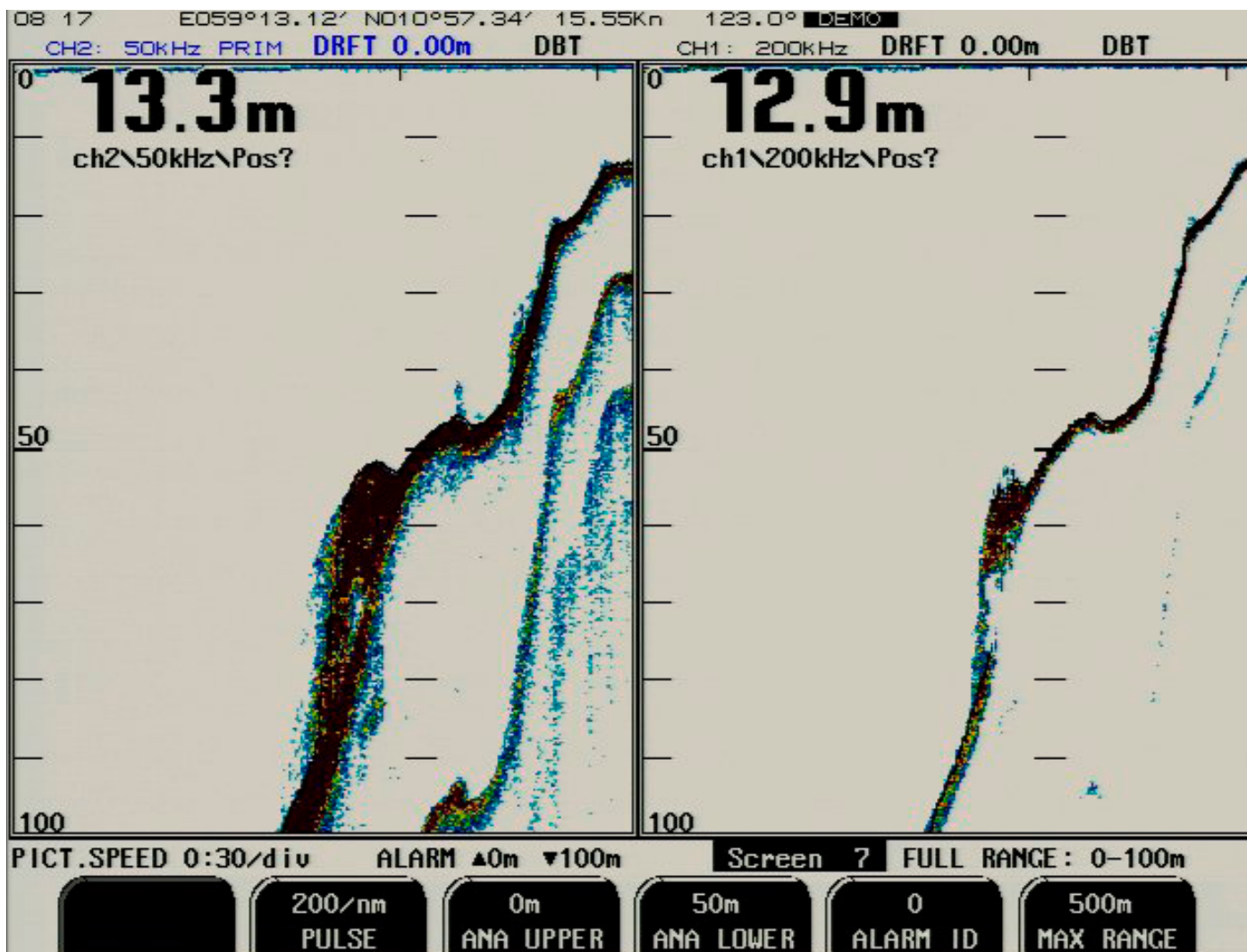

Fig. 2.8. Screen 7. Interface setup screen.

Soft key	Name	Range/value	Default value	Description
1 (Optional)	ENABLE	Pos/neg	Positive	Selection of polarity of remote sounding control signal. Note: This function is operative, if remote sounding control option is installed.
2	PULSE	100, 200, 400, 2000/nm	200/nm	The number of pulses per nautical mile. Setup for pulse input that can be connected to a speed log.
3	ANA UPPER	0 - 49 m	0 m	Analogue output shallow limit, depth value corresponding to 0 V (4 mA) on the analogue output.
4	ANA LOWER	1 - 5000 m	50 m	Analogue output deep limit, depth value corresponding to 10 V (20 mA) on the analogue output.
5	ALARM ID	0 - 999	0	Alarm identifier, used in NMEA alarm sentences to be recognized by the listener. See “NMEA Setup” on page 48 for more information about alarm sentences format.
6	MAX RANGE	200 m 500 m 1000 m 1500 m 5000 m	500 m	Selection of maximal operating range. The maximal detectable depth is dependant on the frequency and properties of the transducer. This setting can be used to avoid unnecessary high range adjustments by the range key.

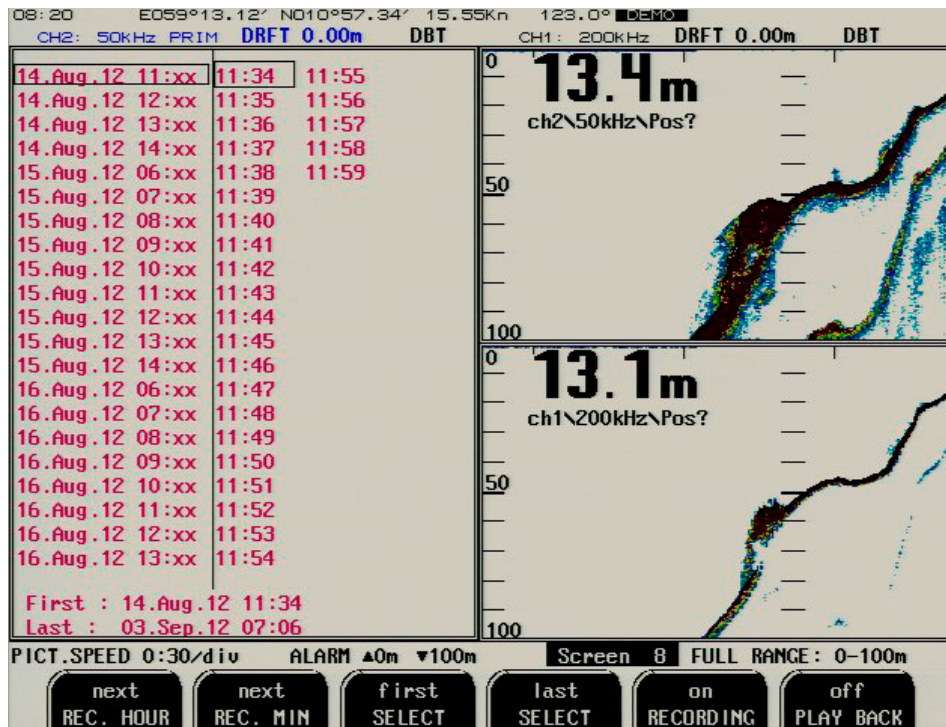

Fig. 2.9. Screen 8. Recordings selection and play back.

If recording mode is activated, the depth and all essential navigational data along with echo sounder settings will be written into the files on the Compact Flash disk. The left half of this screen (recordings directory) represents the list of the recorded files which are sorted by the time of the recordings. The left part of the directory represents the date and hour of the recorded data, while the right part - minutes of the hour/date, which have been chosen by the cursor in the left part. The cursor is indicated by a bar and can be advanced by “REC. HOUR” and “REC. MIN” soft keys. A group is defined by setting the first recording (soft key SELECT first) and the last recording (SELECT last). The selected first and last recordings are indicated in the bottom part of the directory.

Example: Suppose we need to play back the information which has been recorded between 14.Aug.2012 11:34 and 16 Aug.2012 13:38.

- Advance the bar in the left part of the directory by using soft key “REC. HOUR next” on the position 14.Aug.12 11:xx
- Advance the bar in the right part of the directory on the position 11:34 by using soft key “REC. MIN next”
- Press “SELECT first” soft key. The group’s first recording is now selected.
- Advance the bar in the left part of the directory by using soft key “REC. HOUR next” on the position 16.Aug.12 11:xx
- Advance the bar in the right part of the directory on the position 16 Aug 13:38 by using soft key “REC. MIN next”
- Press “SELECT last” soft key. The group’s last recording is now selected.

It is now possible to start a playback. The name of currently displayed recording is indicated in the upper part of the screen.

Note: Playback and recording functions cannot be activated at the same time.

Soft key	Name	Range/value	Default value	Description
1	REC. HOUR	Next		Advance cursor to the next hour of recordings in the directory.
2	REC. MIN	Next		Advance cursor to the next minute of recordings in the directory.
3	SELECT	First		Select group’s first recording.
4	SELECT	Last		Select group’s last recording.
5	RECORDING	On/off	On	Toggles recording mode.
6	PLAY BACK	On/off	Off	Toggles playback mode.

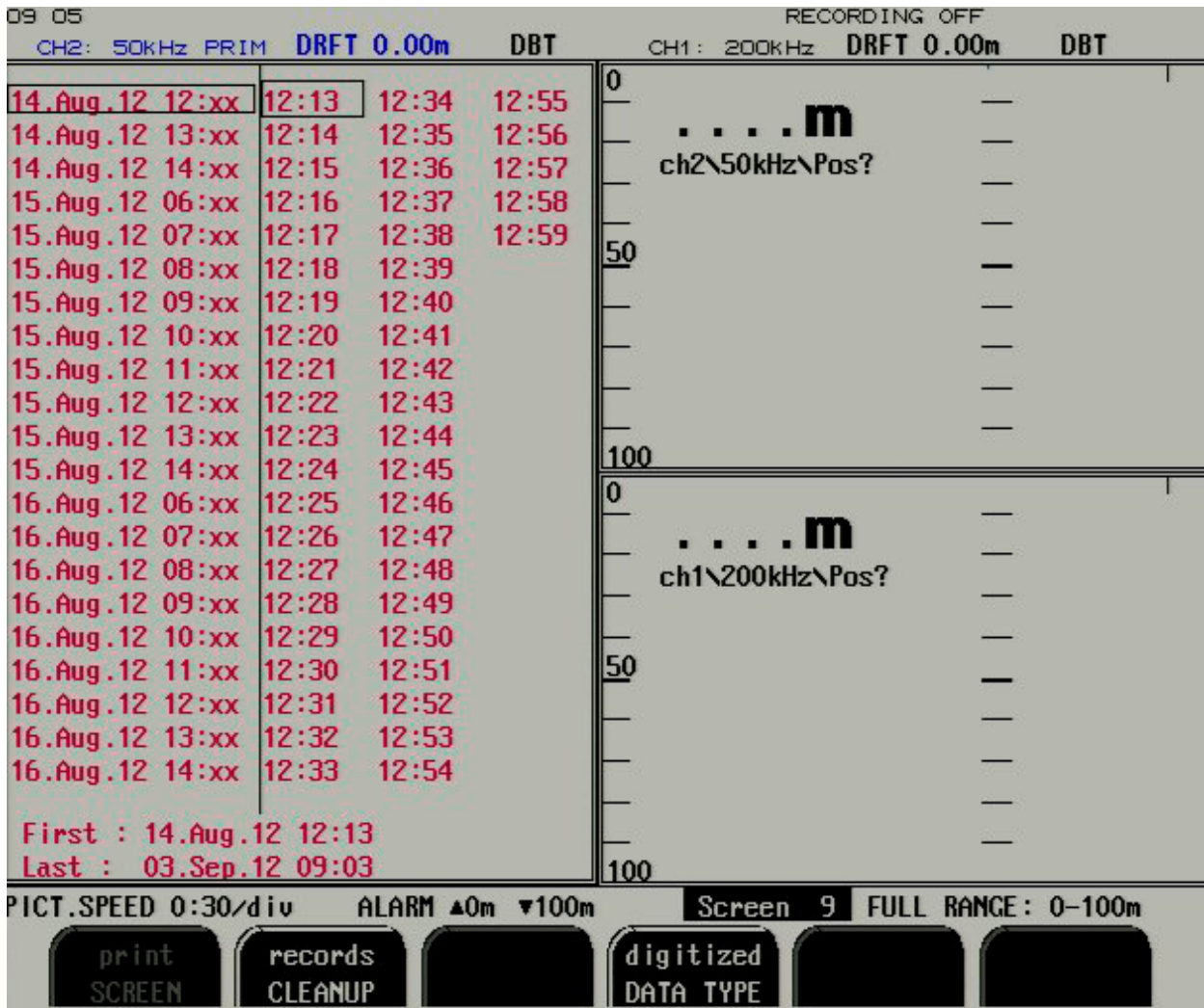

Fig. 2.10. Screen 9. Recordings options.

Soft key	Name	Range/value	Default value	Description
1	SCREEN	Print		Screen hardcopy, can be used for documentation and trouble-shooting.
2	CLEANUP	Records		If the clock is changed, two files for the same date/time can exist. If this is the case, the new data will be added to the original data. If the original data can be destroyed, this button will remove all files with a date which refers to the future.
3				Not used.
4	DATA TYPE	Digitized/ analogue	analogue	If the user is experiencing problems with the software, the profile data can be recorded to the internal compact flash. Note: Softy key active when RECORDING is "off" on screen 8.
5				Not used.
6				Not used.

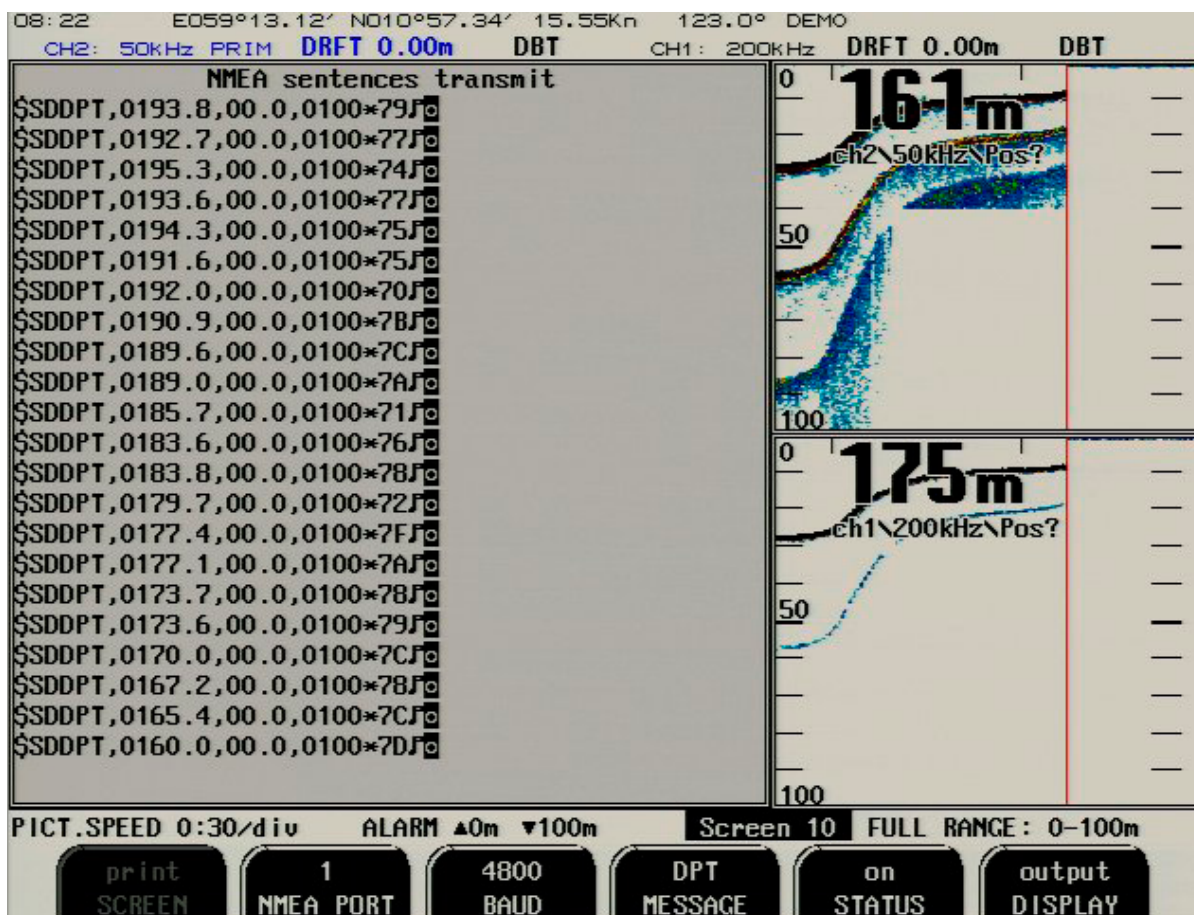

Fig. 2.11. Screen 10. NMEA control screen.

The window on the left part of the screen displays the received or transmitted messages, depending on the selection of the DISPLAY soft key. Useful for verification of received and transmitted messages.

Soft key	Name	Range/value	Default value	Description
1	SCREEN	Print		Screen hardcopy, can be used for documentation and trouble-shooting.
2	NMEA PORT	1/2	1	Select NMEA port number for individual programming and displaying input/output data. The text, displayed in the window and the settings, adjustable by soft keys 3 - 5, corresponds to the NMEA PORT number selected by this soft key.
3	BAUD	4800/9600	4800	Sets the baud rate of the currently selected NMEA PORT (soft key 2). Baud rate will always be same on input and output.
4	MESSAGE	DPT, SKP1, SKP2, DBS, DBT, DBK, ALR	DPT: On SKP1: Off SKP2: Off DBS: Off DBT: Off DBK: Off ALR: Off	List of the supported NMEA formats, provided on the output. See “NMEA Setup” on page 48 for further details.
5	STATUS	On/off		Toggles the status of MESSAGE, selected by soft key 4. If STATUS is “on”, the message is transmitted by the sounder.
6	DISPLAY	Off/input/output	Input	Selects what kind of information is displayed in the text window. <ul style="list-style-type: none"> • Off - None. • Input - Received messages at NMEA PORT, selected by soft key 2. Note: Non accepted messages are displayed in red tekst . <ul style="list-style-type: none"> • Output - Transmitted messages at NMEA PORT, selected by soft key 2.

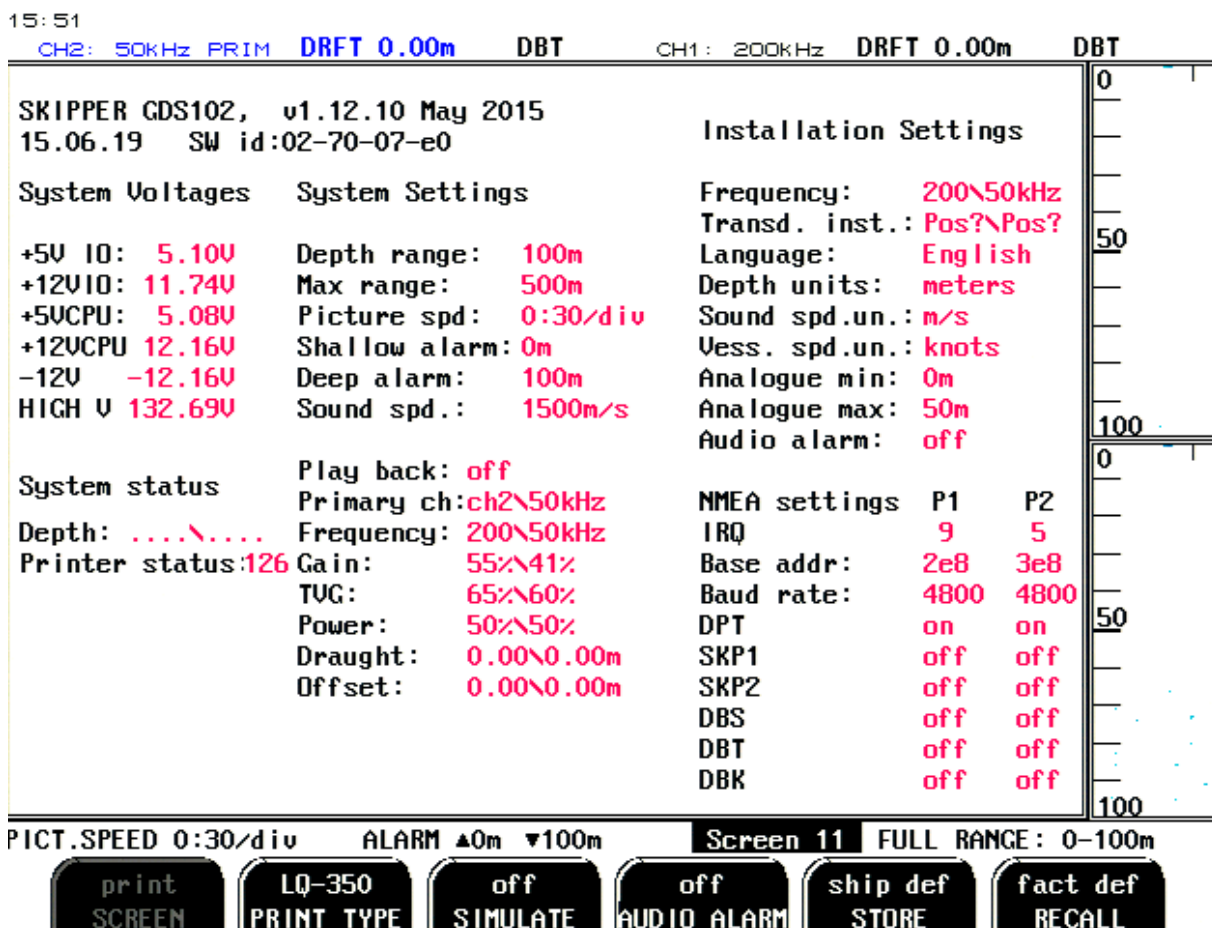

Fig. 2.12. Screen 11. System status screen.

This screen shows a comprehensive list of system settings and parameters.

Soft key	Name	Range/value	Default value	Description
1	SCREEN	Print		Screen hardcopy, can be used for documentation and trouble-shooting.
2	PRINT TYPE	HP Deskjet, Epson D88, LQ-350+	Epson-D88	The printer type. (For Epson LQ-300 printer use LQ-350 driver)
3	SIMULATE	On/off	Off	Toggles built-in simulator. When simulator is activated, flashing “DEMO” text is displayed in the upper right corner of the screen.
4	AUDIO ALARM	On/off	Off	Toggles internal audio alarm function. If disabled (“off”), the internal buzzer will not sound at alarm conditions (only visual indication is provided).
5	STORE	Ship def		Once a realistic setup has been selected, the user can store these settings. If the settings are then changed, the stored setup can be restored using the RECALL button.
6	RECALL	Ship def, fact def		Recalls the previously stored setup options. Short push switches between options while a push for about 5 sec recall the chosen settings. Recall is confirmed by a buzzer beep.

Note: Soft key 1 SCREEN appears “dimmed” if there is no printer connected.

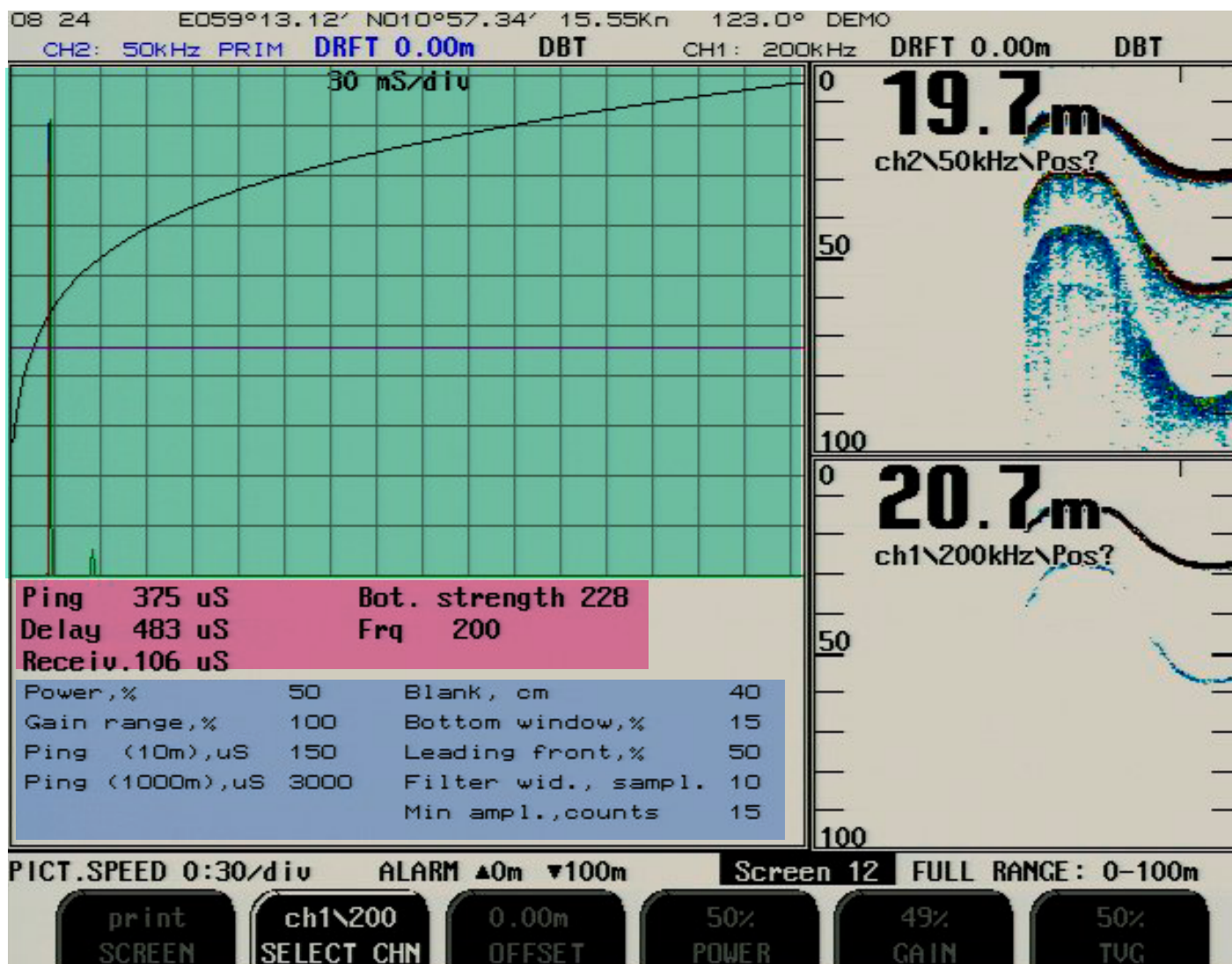

Fig. 2.13. Screen 12. Oscilloscope screen.

The screen can be used for transceiver and transducer trouble-shooting. Left part of the screen consists of the following areas:

A) The graphical real-time presentation of the received echo signal versus time (oscillogram window).

- Horizontal (time) scale factor is indicated in the upper middle part of the oscillogram window. Vertical scale represents the digitized signal value, which corresponds to the signal strength. The signal is presented by a green curve.
- Red vertical marker line is indication of detected bottom.
- Blue vertical marker lines indicate other strong echoes which are also taken into consideration by bottom detection algorithm.
- Horizontal marker line (magenta) is a bottom signal trigger level.
- The logarithmic shaped curve (grey) is displaying the receiver gain settings versus time. The formula $G + T \times \log(R) + a$ is used for gain calculation for each moment of time, where G is a GAIN setting, T - TVG, R - distance of sound travel and a is a constant, compensating for different attenuation of signals with different frequencies.

Only one channel at a time is displayed in oscillogram window. Soft key 2 SELECT CHN can be used to select required channel for observation.

The oscillogram on “[Fig. 2.13. Screen 12. Oscilloscope screen.](#)” on page 24 shows detected bottom signal (next to red marker) followed by secondary and third reflections of bottom signal. Lower signals at the end of the time scale represents the noise, which may be caused by vibration, sea conditions etc.

B) Currently used transceiver settings.

The text below oscillogram window is a real-time presentation of the transceiver parameters of the currently selected channel (by SELECT CHN soft key).

- **Ping** Transmitted pulse width (μ S).
- **Delay** Time between start of the transmitted pulse and start of digitizing received signal (μ S).
- **Receiv.** Digitizing period (μ S).
- **Bot. strength** Digitized (8-bit) signal value of the bottom echo.
- **Frq.** Frequency of the currently selected channel (kHz).

C) Additional parameters.

These parameters are for diagnostics and are not adjustable in this version of the operator unit.

D) Soft key options

Soft key	Name	Range/value	Default value	Description
1	SCREEN	Print		Screen hardcopy, can be used for documentation and troubleshooting.
2	SELECT CHN	Ch1/ch2	Ch2\50	Selected channel enables adjustment of GAIN, TVG, POWER.
3	OFFSET	-99.99 - 0.00	0.00 m	An offset can be set for each transducer channel allowing the user to enter an offset from the keel of the vessel (negative number) If this value is entered, the values sent in NMEA strings DBS and DBK will reflect depth from surface and real depth from keel. DBT will reflect the depth from the transducer. See “ Draught and Offset ” on page 27.
4	POWER	1 - 100 (%)	50 %	Power adjustment. See “ Output Power ” on page 27.
5	GAIN	0 - 100 (%)	Ch1: 55% Ch2: 41%	Gain adjustment (% represents 1 - 50 dB). See “ Gain and TVG (Time Variable Gain) ” on page 27 for further details about GAIN function.
6	TVG	0 - 100 (%)	Ch1: 65% Ch2: 60%	Time Variable Gain adjustment (% represents range 10 - 50 dB suppression). See “ Gain and TVG (Time Variable Gain) ” on page 27 for further details about TVG function.

Principal Functions.

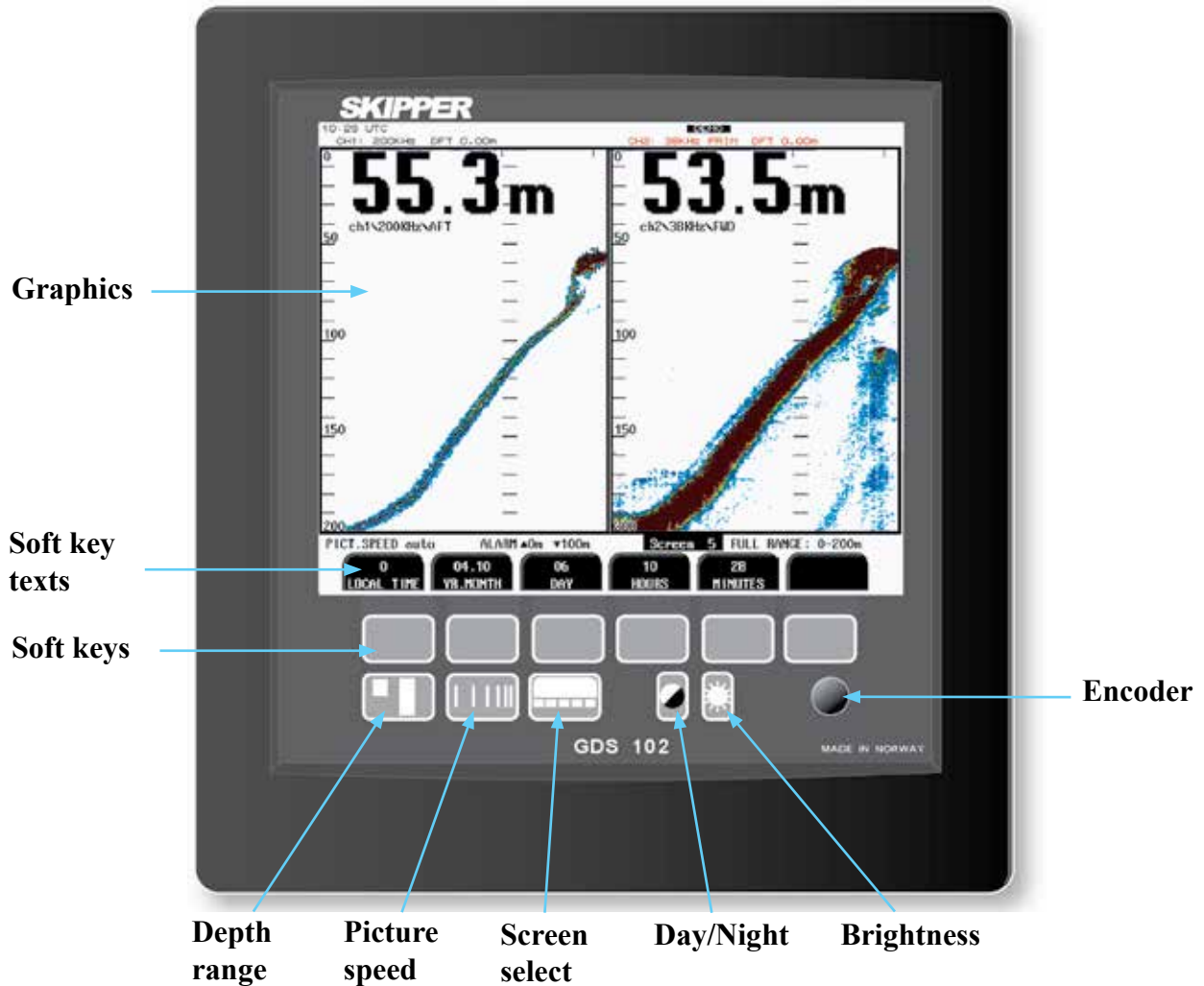

Depth Range

The DEPTH RANGE button can be used to set the depth limit between 10 and 5000 m. The maximal depth range can be reduced by soft key MAX RANGE, screen 7. See “[Fig. 2.8. Screen 7. Interface setup screen.](#)” on page 19. **Note:** The shallower range settings will give higher resolution and therefore better detection accuracy. If autorange function is selected, the range will be adjusted automatically when the depth line is going outside the upper or lower screen limits. In those cases, newly selected range will be selected so the bottom line is in the central part of the screen. New position will be optimized based on the tendency of depth change (increasing or decreasing). The auto range function will operate down to 1600 m, ranges deeper than this must be set manually. This limitation is set to prevent erroneous noise tracking.

Picture Speed

Picture speed may be selected from 30 seconds to 5.0 minutes per division, defining the speed of graphic echogram update and horizontal scrolling of the screen. The pulse repetition frequency (PRF) depends on the selected depth range, and the highest PRF at shallow depths is about 4 pings per second. Automatic picture speed (auto) can be selected by keeping the PICTURE SPEED key pressed and rotating encoder anti-clockwise. In this case, the screen will be updated after each transmission, therefore the picture speed will be dependant on PRF.

Screen select

The SCREEN button facilitates selection of one of the 12 screen and soft key layouts. The 3 primary operation screens may be cycled by repeatedly pressing the SCREEN button. Access to the remaining screens is through encoder operation. The screens are cycled in an endless, bi-directional loop, e.g. turning the encoder counter-clockwise, will activate screen 12 after screen 1.

Brightness (backlight) adjustment

Backlight may be continuously controlled by using the BRIGHTNESS button and the encoder. Press the button and rotate the encoder until a satisfactory setting is obtained, then release the button. The setting is maintained in the non-volatile memory, and the last setting is restored on power-up.

Day/Night

Day/Night vision may be selected by pressing this button.

Gain and TVG (Time Variable Gain)

Gain and TVG settings allow to form the resultant gain curve, used by the receiver amplifiers. Signal attenuation in water is proportional to logarithm of distance traveled. The formula $G + T \times \log(R) + a$ is used for gain calculation for each moment of time, where G is a GAIN setting, T - TVG, R - distance of sound travel and a is a constant, compensating for different attenuation of signals with different frequencies. The gain, in principle, is an offset used to compensate for tolerances of the transducers resultant sensitivity (transmitting and receiving sensitivity).

TVG setting can be used to provide different suppression of the echoes returned closer to the transducer. This may be desirable in case of strong reflections from the temperature layers, air bubbles and other obstacles. Higher TVG settings will result in lower suppression. Both GAIN and TVG should be adjusted individually for each channel to achieve a stable bottom detection at all depths in the operating range.

Digital indication

On the operation screens, two sizes of large digital depth indicators may be selected from screen 2. See [“Fig. 2.3. Screen 2. Display and print settings.” on page 14.](#)

Frequency

The operating frequency of each channel must be selected by using the DIP switches on the transceiver PCB, see [“Frequency setup” on page 50](#), while indicated values should be adjusted accordingly on screen 4, see [“Fig. 2.5. Screen 4. Transducer details.” on page 16.](#)

Output Power

Power may be adjusted from 1 to 100 %. Power reduction can be useful in case of difficult shallow water conditions. Too high power in such cases will possibly saturate the receiver or cause detection of unwanted secondary bottom or surface echoes.

Draught and Offset

Draught may be compensated to allow real depth from surface to be shown on the screen and printout. Draught will always be the distance to the lowest point on the vessel (near the transducer). If the transducer is not at the lowest point, an offset can be added to compensate for this. This offset is added such that the depth from keel and depth from transducer can also be given out correctly in the NMEA

formats. The screen will prioritize surface depth, then keel depth and then transducer depth, based on which parameters are non zero. If two channels are in use, the draught and offset values should be adjusted for each channel individually. Draught compensation is indicated on top of the screen by a number and a text (DRFT) to alert the operator to the fact that the shown depth value is adjusted. Draught is used to correct the Depth Below Transducer (DBT) to Depth Below Keel (DBK) or to Depth Below Surface (DBS). This is used when the transducer is not at same position as the lower part of the keel/bottom or if ship want to know the real water depth from surface. Dependant on draught/offset settings, the text (DBT, DBS or DBK) is also displayed. Draught may be compensated to allow real depth from surface to be shown on the screen, the printout and in all the NMEA relevant formats.

Draught/Offset settings	Top screen indication
Draught = 0 (Default)	DBT
Draught > 0	DBS
Offset < 0	DBK

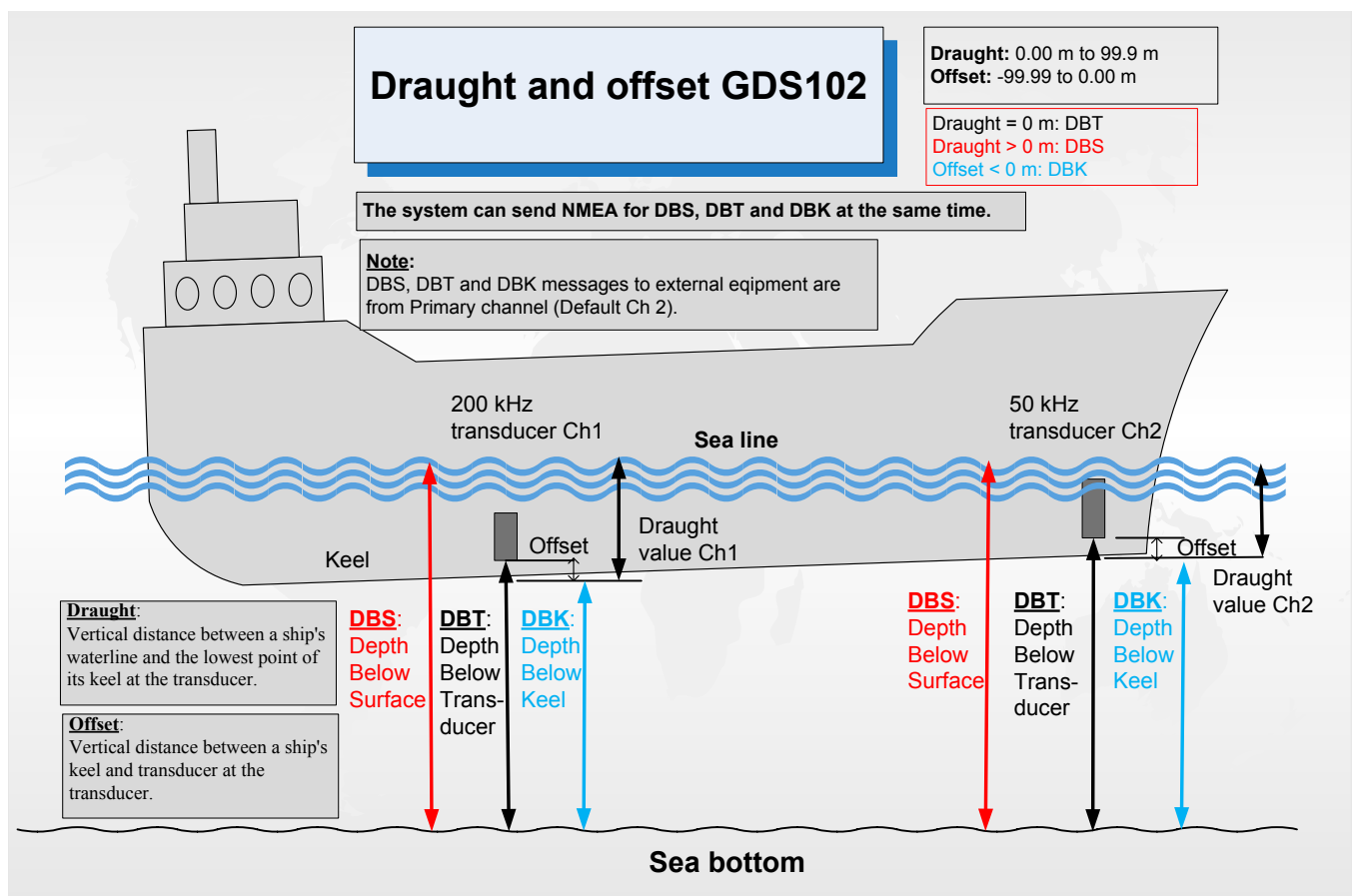

External Printer Operation

The optional external printer is started and stopped by the PRINT button. The printer may be used for continuous printing over a period of time or the current screen contents may be dumped to the printer for reference if something interesting is observed.

- The PRINT button (screen 2) switches continuous printing on and off.
- The SCREEN print buttons will initiate a screen dump of the present screen contents.

Note: A second push on the SCREEN print button before the printing is finish, will terminate the ongoing printing.

If the printer is switched off or not connected, the print button is dimmed. The printout has limited text functions. The value besides Prim is the primary frequency. The value besides fr (xx/yy) is the two frequencies in use.

Alarm settings and acknowledgment

Depth alarm settings are performed from screen 1. See [“Fig. 2.2. Screen 1. Gain, TVG and alarm settings.” on page 13](#). Alarm limits are always referred to as the depth calculated at the primary echo sounder channel. The local alarm buzzer may be disabled from screen 11, (see [“Fig. 2.12. Screen 11. System status screen.” on page 23](#)) but the external alarm relay will always operate. If the local alarm buzzer is enabled, audible alarm will be provided at alarm conditions. The type of alarm conditions (shallow water alarm or deep water alarm or both) is visually indicated on the screen in the form of a flashing corresponding alarm setting (lower part of the screen, next to text ALARM). Local alarm buzzer and external alarm relay can be disengaged either locally (by pressing any key on the panel) or remotely (external alarm reset input or NMEA message), while the visual alarm will remain on the screen until it is reset locally.

Note: The only way to disable the alarms completely, is to reduce the shallow water alarm to zero depth and increase the deep water alarm to maximum range. Alarm limits are enforced with hysteresis.

Clock and Calendar Settings

Manual clock and calendar adjustments are carried out on screen 5, see [“Fig. 2.6. Screen 5. Calendar and clock setting.” on page 17](#). If a satellite navigator giving UTC messages is connected to the NMEA input, the clock and calendar will be automatically updated and manual adjustment is not possible.

Data Logging (Recordings Memory)

GDS102 has a capability of recording continuously for 24 hours. All related functions are presented on screens 8 and 9; see [“Fig. 2.9. Screen 8. Recordings selection and play back.” on page 20](#) and [“Fig. 2.10. Screen 9. Recordings options.” on page 21](#) for further details. Depth, time and whatever navigational information is available (position, speed, heading), are stored continuously. The most important settings of the sounder (range, gain, power etc.) are also being recorded for further possible analysis. New depth information is continuously stored in the memory while the oldest samples are discarded. By switching RECORDING “off”, the stored 24 hours will be kept in the memory and no new samples will be written. As a warning that the memory is not recording, “History off” will flash in the upper part of the screen. PLAY BACK on, will start playing the contents of the history memory on the screen. As a warning that the displayed data is from the memory and not real time, currently used file name is flashing in the upper part of the screen. The file name contains information about date and time when the data was recorded. The HOURS and MINUTES buttons used with the encoder, will enable positioning within the 24 hour memory to observe the desired part of the time frame during playback.

Note: If installed, (default and recommended) history data will be recorded on the external Compact Flash. If the external Compact Flash is not installed, the history data will be recorded on the “program” Compact Flash located on the rear side of the CPU board.

System ON/OFF

The soft key SYSTEM on/off on screen 2 can be used to set the sounder in standby mode and switch off the major power consuming elements (transmitter, LCD screen etc.) The sounder can be restarted by pressing any button. See [“Fig. 2.3. Screen 2. Display and print settings.” on page 14](#).

Note: The unit is still energized!!! Do not perform any reconnections or service procedures before switching off the mains on the terminal PCB inside the cabinet.

Simulator

The GDS102 contains a built in simulator to test the screen and various interface signals. The simulator can be switched on and off on screen 11. When the simulator is operating, “Demo” will flash in the upper part of the screen. See [“Fig. 2.12. Screen 11. System status screen.” on page 23.](#)

Status Screen

The status screen, screen 11, shows a list of various system parameters useful for documenting the system setup and system operating status. The contents of this screen will provide valuable information in situations where manufacturer support is required. See [“Fig. 2.12. Screen 11. System status screen.” on page 23.](#)

Oscilloscope Screen

The oscilloscope screen, screen12, is useful when monitoring transceiver performance. The oscillogram shows the signal returned from the transceiver plotted against time and will enable service personnel to evaluate system performance and facilitate any troubleshooting. See [“Fig. 2.13. Screen 12. Oscilloscope screen.” on page 24.](#)

Nonvolatile Parameter Memory.

The system contains non-volatile memory to maintain installation and user parameters like gain, power, unit of measurement selection, backlight settings, etc. These parameters are kept in the battery backup memory and are automatically restored on power-up. If the user parameters have never been set, default values are used. Make sure that jumper JP200 on the I/O board, which activates the battery operation, is installed in correct position. See [“Fig. 3.7. Back-up battery jumper JP200, on I/O board.” on page 39.](#)

Data type

The GDS102 software has a function where the profile data can be saved onto the compact flash disk used for programming. If the user has problems with the system detecting the bottom even though it is clearly visible on screen, these files can be sent to SKIPPER for analysis.

Basic Algorithm Considerations

Bottom detection

GDS102 employ a bottom detection algorithm that will try to extract the bottom signal from all kinds of noise and secondary echoes. When GDS102 is tracking the bottom normally, a thick black line is shown. If the software can not detect bottom within several pulses, the bottom line disappears and a warning beep is heard. Dots are then displayed in the digital indicator window instead.

Ping to Ping filtering

Part of the bottom detection algorithm is the ping to ping filtering. The next bottom is searched for in a time and strength window based on the strength and timing of the previous bottom echoes. This procedure reduces the probability of tracking schools of fish or secondary echoes as bottom. If no bottom is detected in the calculated window, the window is gradually increased in size until the full time and strength window is used.

3. Installation

Standard System Supply

A basic GDS102 system consists of the following units. (See [“Fig. 3.1. Basic System Configuration.”](#) on page 32):

1. Operator unit with installation material.
2. Transducer junction box(es). See [“Transducer Junction Box”](#) on page 33.
3. Approved transducer steel tank(s) and sea valves.
4. Transducer(s) with attached cable(s) and installation material.

Transducer Installation

Single transducer location

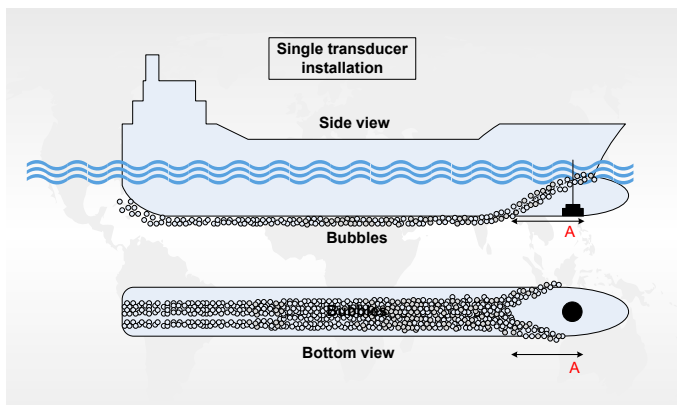

A transducer should be installed in an area securing optimal measurement free from noise and aeration. Transducers are normally installed in the noise free area in the foreship (see A on fig.)

Optimal system operation is achieved by fitting the transducer as deep as possible on the hull. The transmitting surface of the transducer must be installed horizontally.

Do not mount transducers close to the propeller or aft of other hull installations (outlets, vents or other protruding details). It is necessary to select a part of the hull that is submerged under all load and speed conditions, and to avoid positions where air is trapped in heavy weather.

If a flat, horizontal section is not available for transducer fitting, the shipyard must construct a suitable bed.

Dual transducer location (fore/aft)

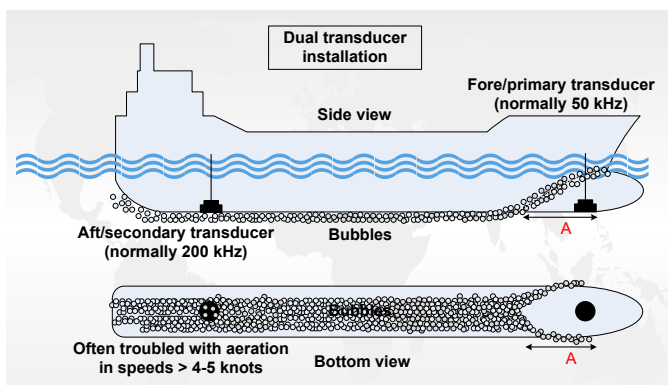

Larger vessels are often fitted with two transducers, one fore and one aft (see fig.)

The fore transducer is the primary transducer, (normally 50 kHz).

The aft transducer is a secondary transducer, (normally 200 kHz).

The aft transducer will be troubled with aeration and noise and will not operate in speed >4-5 knots. It is used to measure aft depth in shallow water.

Dual transducer installation(fore/fore)

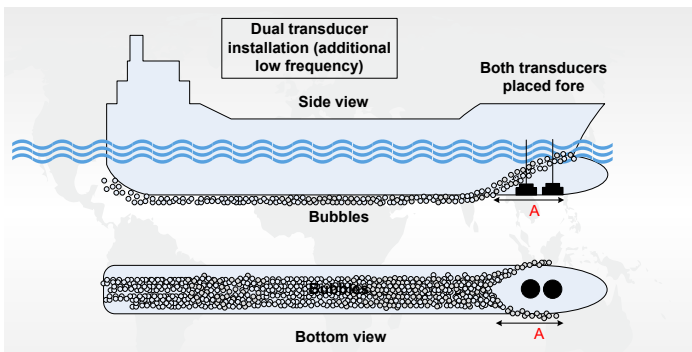

For echo sounders with two transducers with different characteristics, (example 50 kHz navigational and 38 kHz low frequency), both transducers may be installed fore in the ship.

Transmission in the air must be avoided! This may cause damage of the element.

Installation Details

Refer to SKIPPER's standard installation manuals regarding tank/sea valve installation, welding, cable glands etc. You will find these on our web site, www.skipper.no.

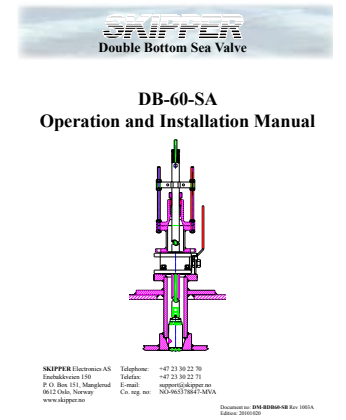
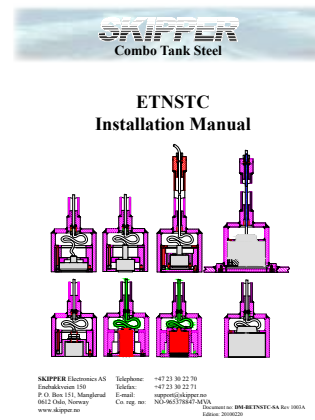
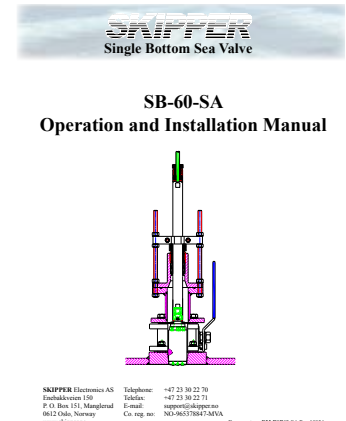
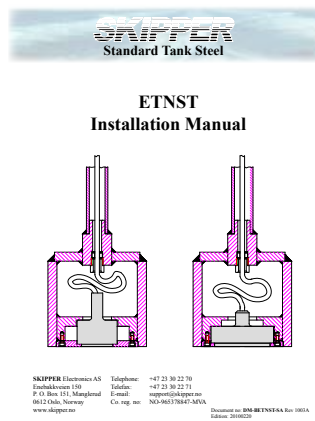
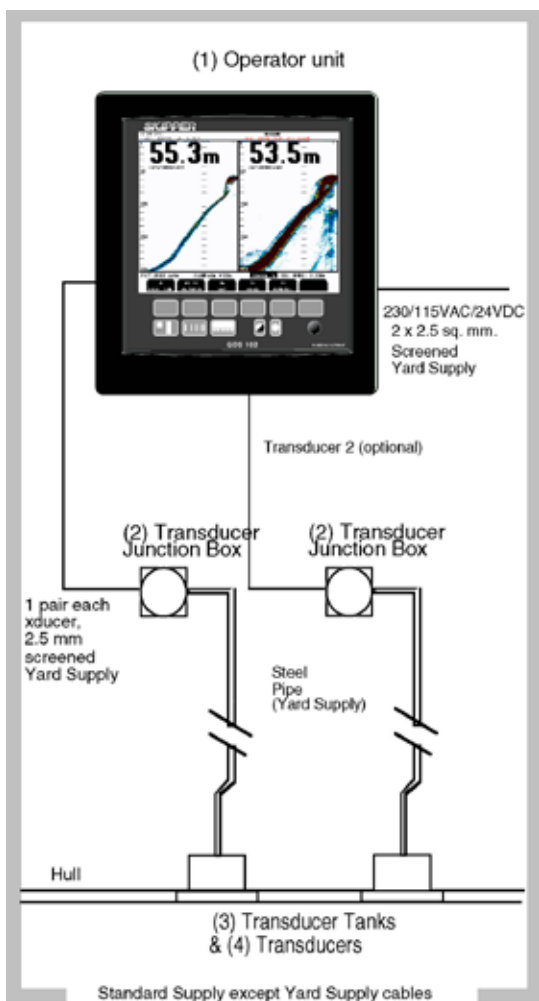

Fig. 3.1. Basic System Configuration.

Transducer Junction Box

The standard cable fitted on the transducer is 25 m or 40 m and may be shortened. The junction box is used to interconnect the transducers fixed cable to a yard supply extension cable if the total required cable length is longer than the standard cable. It is required to run the standard cable in a steel protecting pipe to above the highest water level in tank installations.

Special requirements apply in areas with explosive conditions. The junction box must always be mounted outside such areas.

Interconnect the transducer pair and its screen in the junction box, **but do not ground the screen here.**

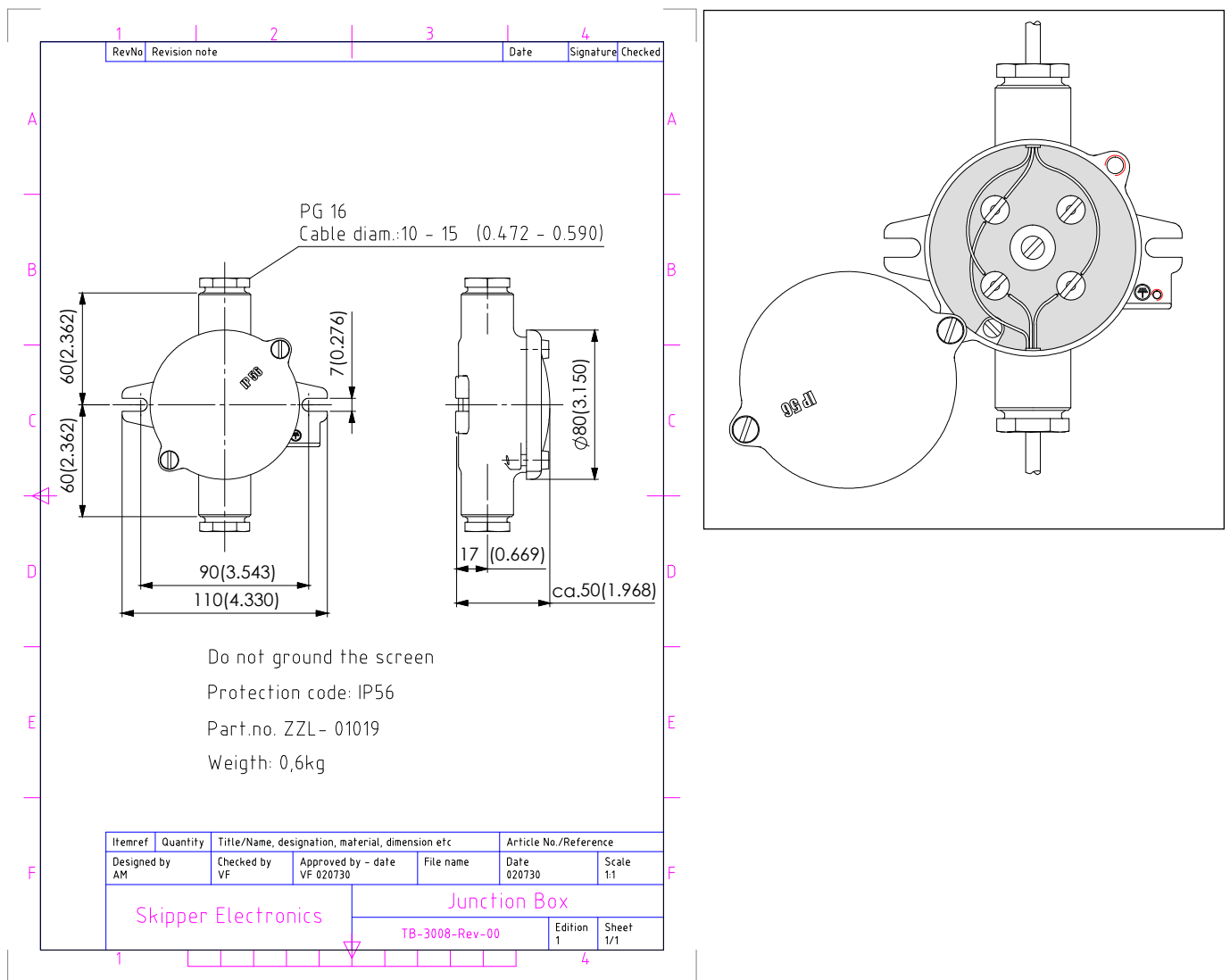

Fig. 3.2. Transducer junction box.

Operator Unit Installation

Select a position to provide free view of the panel as well as easy access during operation and service. The operator unit may be mounted flush (optional bracket are needed) in a panel, desktop mounted or directly mounted onto a bulkhead. Fig. 3.3 shows the operator unit along with the main installation dimensions. If the unit is to be flush mounted, the shown cut-out and recession depth dimensions must be observed. See [“Fig 3.3. Operator unit.” on page 35.](#)

Remember to leave room in front of the unit to open the door a full 90 degree.

Do not perform installation work with system power applied!!

Cables are led through the appropriate cable glands as follows:

- The cable from the transducer(s) should normally occupy the left gland.
- The right gland is used for power supply connection.
- The centre ones are used for any interface signals connected.

Power supply may be either 115/230 V AC or 24 V DC. Power consumption is app. 60 W at 24 V, app. 80 W at 115/230 V AC.

The transducer is always connected with 1 pair plus screen. See [“Fig. 3.8. Terminal board connections” on page 43.](#)

115/230 V selection on Combo Terminal board inside Display Unit

If the AC power system is 115 V, GDS102 must be prepared for 115 V AC by re-connecting the connectors J102, J103 as shown in fig. 3.4. See [“Fig. 3.4. AC Voltage selection and fuses.” on page 36.](#)

This diagram also shows position of fuses for 115/230 V AC and 24 V DC. These fuses are normal 5 x 20 mm glass fuses.

AC supply: FS100, FS101: 230 V: 0.5 A slow blow.
FS100, FS101: 115 V: 1 A slow blow.

DC supply: FS102: 24 V: 3.15 A slow blow.

When the installation is complete, and power is connected to the operator unit, the appropriate power switch by the power terminals is switched on. For daily operation, these switches may stay on and the unit is switched off by pressing the SYSTEM off button on screen 2. See [“Fig. 2.3. Screen 2. Display and print settings.” on page 14.](#) The unit is switched on by pressing any button.

Both 115/230 V AC and 24 V DC power may be connected and switched on at the same time. If one of these supplies shuts down, changeover is automatic.

Important

When doing service or repair, please wait two minutes after power off, before unplugging internal connectors.

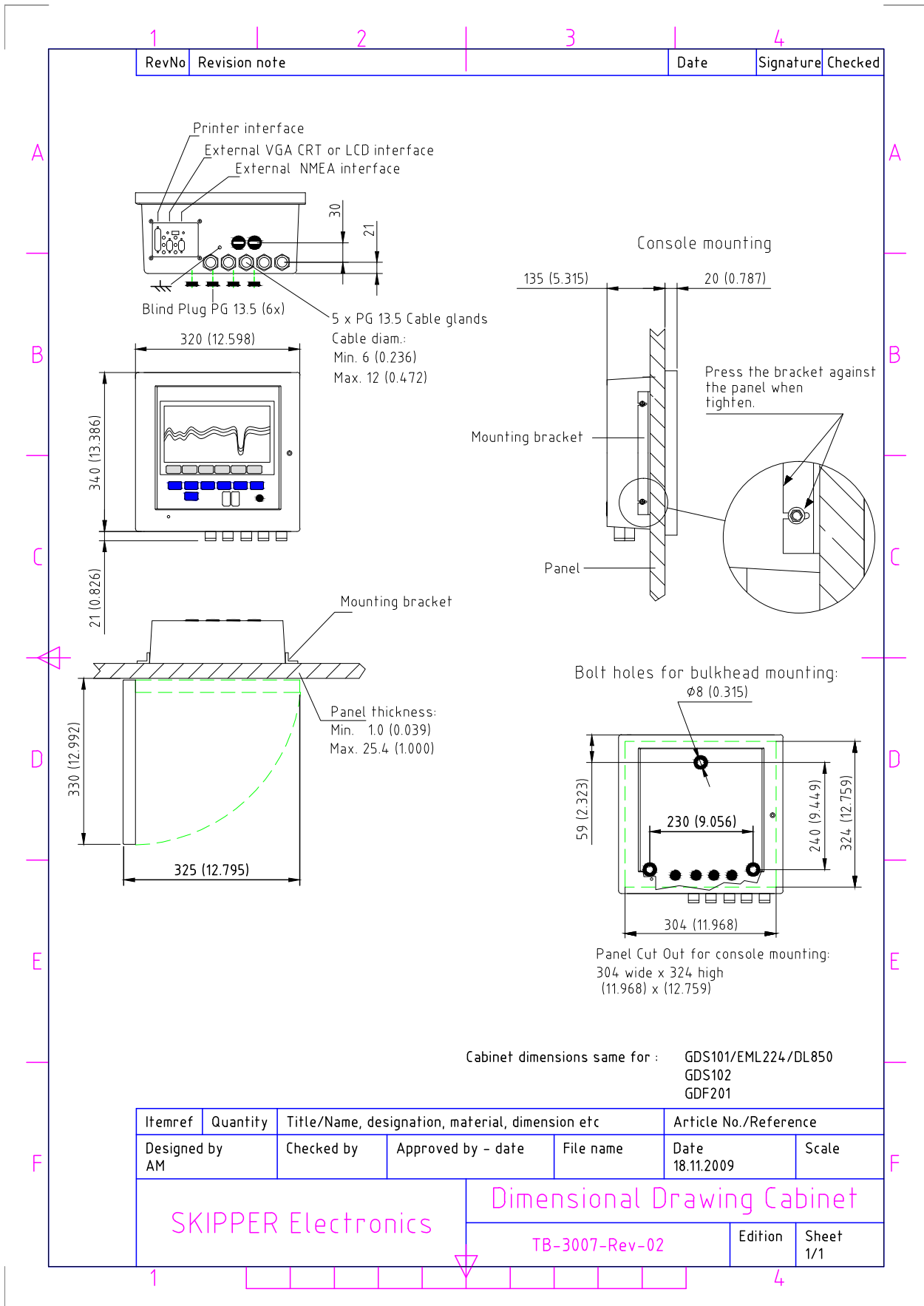

Fig 3.3. Operator unit.

Voltage selection connectors and fuses, Terminal Board

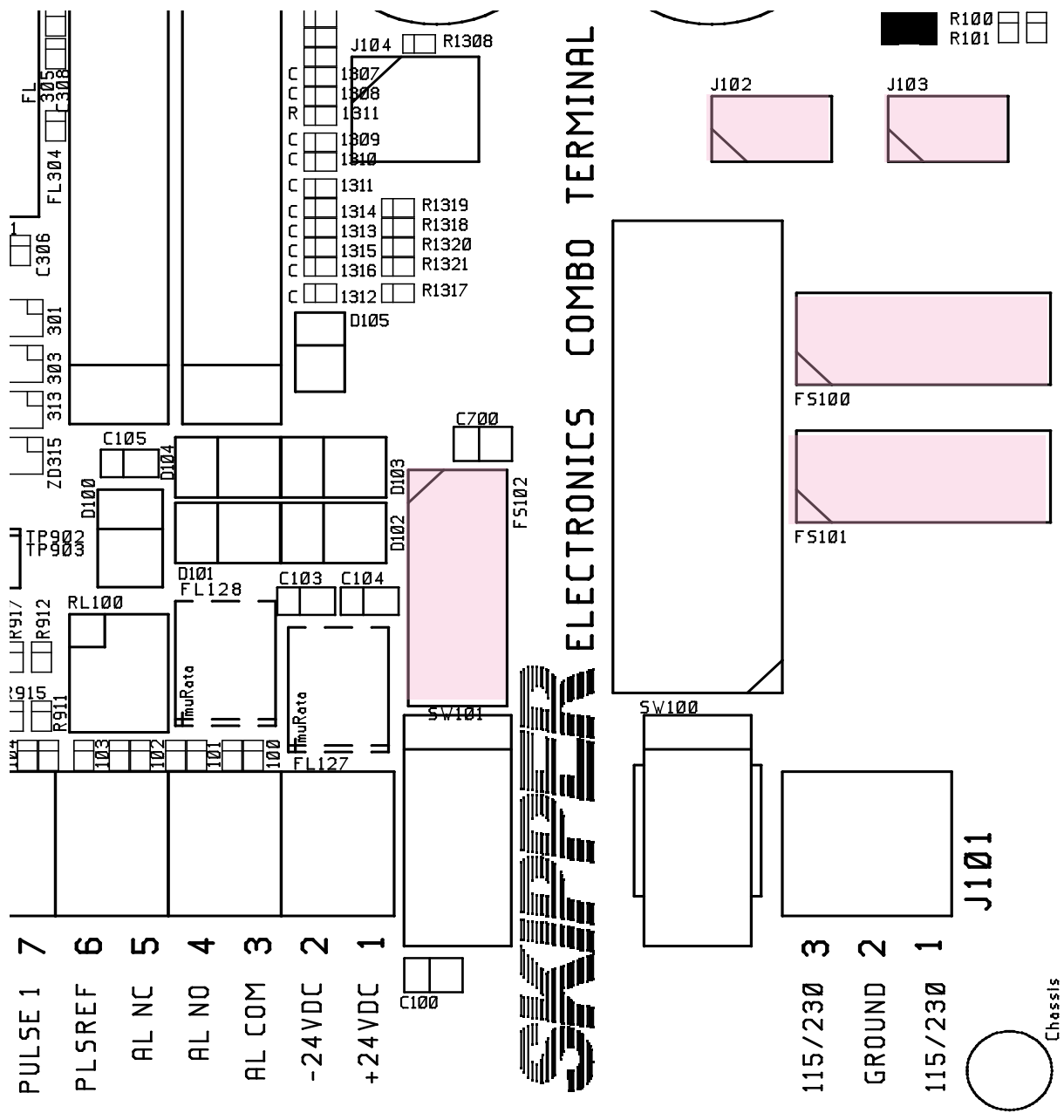

Fig. 3.4. AC Voltage selection and fuses.

Transformer primary to:

- J102 for 230 V AC.
- J103 for 115 V AC.

(Fit dummy plug on opposite connector for protection).

Fuses:

- 230 V AC: FS100 and FS101 must be 0.5 A slow blow.
- 115 V AC: FS100 and FS101 must be 1.0 A slow blow.
- 24 V DC: FS102 must be 3.15 A slow blow.

External Interface Ports



Fig. 3.5. Data Communication Interfaces.

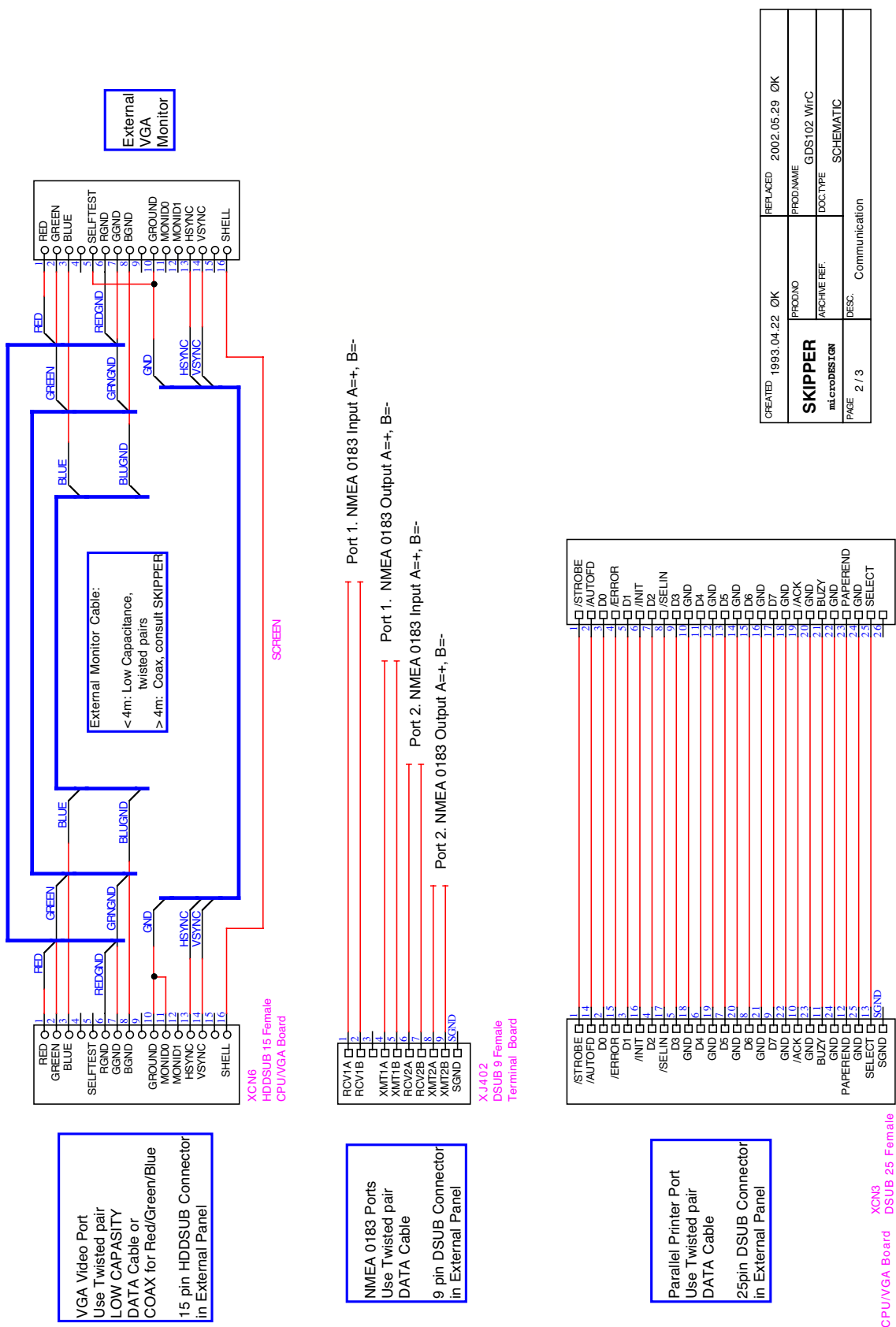

CREATED	1993.04.22	ØK	REVISED	2002.05.29	ØK
SKIPPER			microDSUB1GN		
PRODDNO			PRODDNAME	GDS102_WiTC	
ARCHIVE REF.			DOC TYPE	SCHEMATIC	
PAGE	2 / 3		DESC.	Communication	

Fig. 3.6. Data Communication Interfaces.

Back-up battery jumper JP200

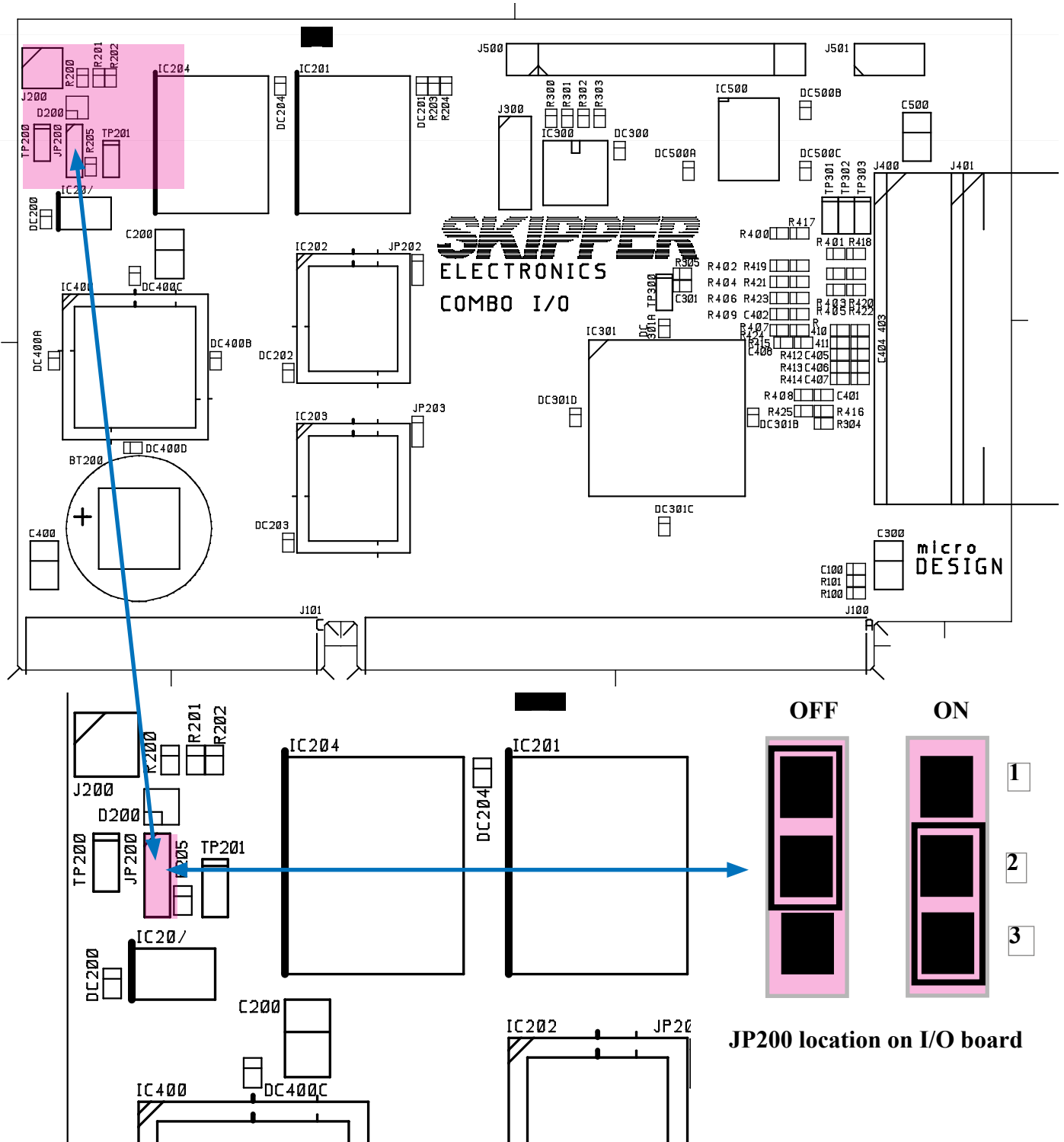

Fig. 3.7. Back-up battery jumper JP200, on I/O board.

Important: After the installation is complete and the system power is applied, it is necessary to connect the back-up battery to provide power to the user parameters during system power failure. Refer to fig. 3.7 for the correct setting of the battery jumper “ON” position 2 to 3. This jumper should be set to the “OFF” position 1 to 2 only during extended unit storage periods. The battery is in use only when no power is applied to the power terminals.

Interfacing

NMEA interface

The GDS102 NMEA outputs provide NMEA 0183 format information for other equipment with NMEA 0183 inputs. Baud rate is 4800 or 9600, 8 bit, no parity. Several messages may be selected on screen 10 (see [“Fig. 2.11. Screen 10. NMEA control screen.” on page 22](#)) and the enabled messages are transmitted with a maximum interval of one per second. The NMEA inputs accept speed, position, heading and UTC time messages from various navigators and compasses. The NMEA outputs and inputs are available on the XJ402 connector on the external panel. See [“Fig. 3.5. Data Communication Interfaces.” on page 37](#), [“Fig. 3.6. Data Communication Interfaces.” on page 38](#), [“Fig. 3.8. Terminal board connections” on page 43](#) and [“Fig. 4.1. nmea connector XJ402.” on page 49](#) for more details. Each of the outputs can supply more than 20 mA and can therefore drive at least 10 other standard NMEA 0183 inputs.

Note: The factory setting of jumper JP400 on the terminal board (underneath the dual transceiver PCB, see [“Fig. 3.8. Terminal board connections” on page 43](#)) is 1 to 2, providing two individually controlled NMEA outputs. If the jumper is moved in position 2 to 3, both outputs are controlled (baud rate and scope of transmitted sentences) by the settings of NMEA PORT 2 on screen 10. If the jumper is removed, only one NMEA output is available (NMEA PORT 2). In the last case, the settings for output of COM PORT 1 have no meaning. Both NMEA inputs are always available and individually programmable (baud rate) regardless of the setting of JP400. See [“NMEA Setup” on page 48](#) for a complete list of transmitted and received messages.

Alarm relay

An alarm relay is provided for interconnection to external alarm systems. This relay is normally energized, and is released by alarm conditions (shallow or deep alarm). See [“Fig. 3.8. Terminal board connections” on page 43](#), [“Fig. 3.10. Input/Output Circuitry 2” on page 45](#) and [“Fig. 3.11. Input/Output Circuitry 3” on page 46](#) for connection details.

The terminals have the following meaning:

J100 Symbol	J100 #	Description
AL COM	3	Common terminal.
AL NO	4	Normally open contact.
AL NC	5	Normally closed contact. (Normal = “No alarm” condition)

Analogue interfaces

GDS102 is equipped with 2 analogue outputs to supply analogue repeaters or other equipment with analogue inputs. The signals are galvanically connected to the GDS102. Standard range is 0 - 10 V or 4 - 20 mA corresponding to shallow (ANA UPPER) and deep (ANA LOWER) settings. For more details, see [“Fig. 2.8. Screen 7. Interface setup screen.” on page 19](#), [“Fig. 3.8. Terminal board connections” on page 43](#), [“Fig. 3.9. Input/Output Circuitry 1” on page 44](#), [“Fig. 3.10. Input/Output Circuitry 2” on page 45](#).

Note: The depth information from the sounder’s **primary** channel is always used for updating analogue outputs.

The outputs can be calibrated according to the requirements of the external equipment, ref. description of screen 7. See [“Fig. 2.8. Screen 7. Interface setup screen.” on page 19.](#)

J100 Symbol	J100 #	Description
ANAOUT3	25	Current output (4 - 20 mA).
ANAOUT2	24	Voltage output (0 - 10 V).
ANAOUT1	23	Not used.
ANAREF	22	System ground, common negative reference for analogue outputs.

Transmitter trigger pulse and bottom pulse outputs

Two optocoupler outputs provide a transmitter trigger pulse and bottom pulse output. These outputs can be used to connect a repeater e.g. SKIPPER IR201, or to synchronize other hydroacoustic equipment to avoid interference. See [“Fig. 3.8. Terminal board connections” on page 43](#), [“Fig. 3.9. Input/Output Circuitry 1” on page 44](#) and [“Fig. 3.10. Input/Output Circuitry 2” on page 45](#) for output details.

J100 Symbol	J100 #	Description
(OPT)VE	15	Transmitter trigger pulse emitter.
OPTVC	14	Transmitter trigger pulse collector.
OPTDE	13	Bottom pulse emitter.
OPTDC	12	Bottom pulse collector.

Note: The value of the depth, measured at the **primary** channel is always used to control bottom pulse function. In the case where bottom is not detected, no bottom pulse is provided at all.

External alarm reset input

The external alarm relay and local audio alarm can be reset externally by a potential free contact* connected to REMOTE KEY+/- inputs (J100 pin 9 and 11) on the terminal board. If an optional remote keyboard is used, external reset button can be connected in parallel with the keyboard, or the remote keyboard can be used for external alarm reset.

* A potential free contact is essentially an electronic galvanically isolated switch which closes when it is active.

External printer connection

The external HP Deskjet or Epson D88/LQ-300+ printer with Centronics interface can be connected to the GDS102 parallel port, located on the external panel of the cabinet. See [“Fig. 3.5. Data Communication Interfaces.” on page 37](#) for port allocation and [“Fig. 3.6. Data Communication Interfaces.” on page 38](#) for connector details.

Options

Repeaters/Slaves

Graphic CRT (VGA), LCD displays or digital depth slave repeaters may be connected to the system. The graphic repeaters may require the installation of line driver units dependant on the distance between the main system and the repeater. See [“Fig. 3.5. Data Communication Interfaces.” on page 37](#) and [“Fig. 3.6. Data Communication Interfaces.” on page 38.](#)

Remote Keyboard

The unit may optionally be operated from a remote keyboard. If you have combo terminal PCB version E (or higher), a jumper is provided (JP900) for 12 V. See [“Fig. 3.8. Terminal board connections” on page 43](#). Otherwise modifications must be made (contact SKIPPER).

J100 Symbol	J100 #	Description
KEYB-	9	Keyboard reference.
12 volt	10	Keyboard 12 V supply.
KEYB+	11	Keyboard signal.

Remote Sounding Control

This option lets the GDS102 being controlled remotely in continuous/edge/level/single ping modes. If installed, these options are accessible on screen 3. See [“Fig. 2.4. Screen 3. Power adjustment and options.” on page 15](#), [“Fig. 3.8. Terminal board connections” on page 43](#), [“Fig. 3.9. Input/Output Circuitry 1” on page 44](#) and [“Fig. 3.10. Input/Output Circuitry 2” on page 45](#) for more details.

J100 Symbol	J100 #	Description
PLSREF	6	Control signal input -.
PULSE2	8	Control signal input +.

Control signal polarity can be selected on screen 7. See [“Fig. 2.8. Screen 7. Interface setup screen.” on page 19](#).

Optocoupler 2 output

J100 Symbol	J100 #	Description
OPT2DC	18	Direction Collector.
OPT2VC	17	Velocity Collector.
OPT2EE	16	Common Emitter.

The **“silent”** (non-transmitting) and **“sounding”** (transmitting) modus is indicated by the change of the state of optocoupler OPT2VC/OPT2EE (J100 pin 16 and 17).

- When in **“sounding”** (transmitting) modus, the light emitting diode inside the opto coupler is **ON** and the “switch” is closed.
- Alternatively, when in **“silent”** (non-transmitting) modus, the light emitting diode inside the opto coupler is **OFF** and the “switch” is open.
- When the sounder is turned off, the described “switch” will remain open, indicating no transmission.

EMC

Important: To meet the stringent EMC requirements for this type of equipment, two ferrite filters are supplied with the display unit. The transducer wires should be looped two times through these as shown in [“9. EMC mounting kit” on page 70](#).

Terminal board connections

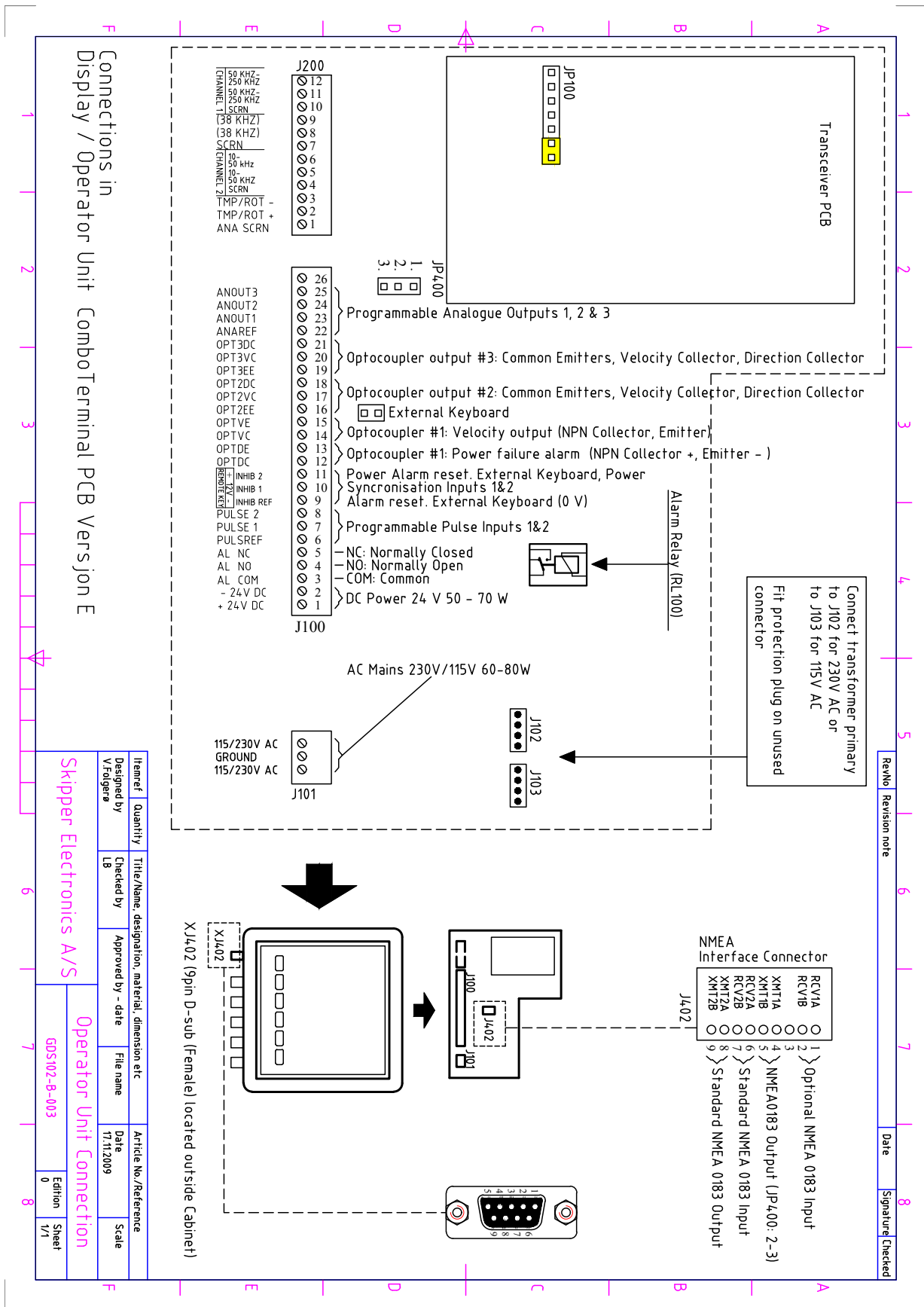

Fig. 3.8. Terminal board connections

Itemref	Quantity	Title/Name, designation, material, dimension etc	Article No./Reference
Designed by	LB	Checked by	17/12/09
V.Folgerø		Approved by - date	
Skipper Electronics A/S		File name	Scale
Operator Unit Connection		GDS102-B-003	0
		Edition	1/1

Revno	Revision note	Date	Signature	Checked

Input/Output Circuitry 1

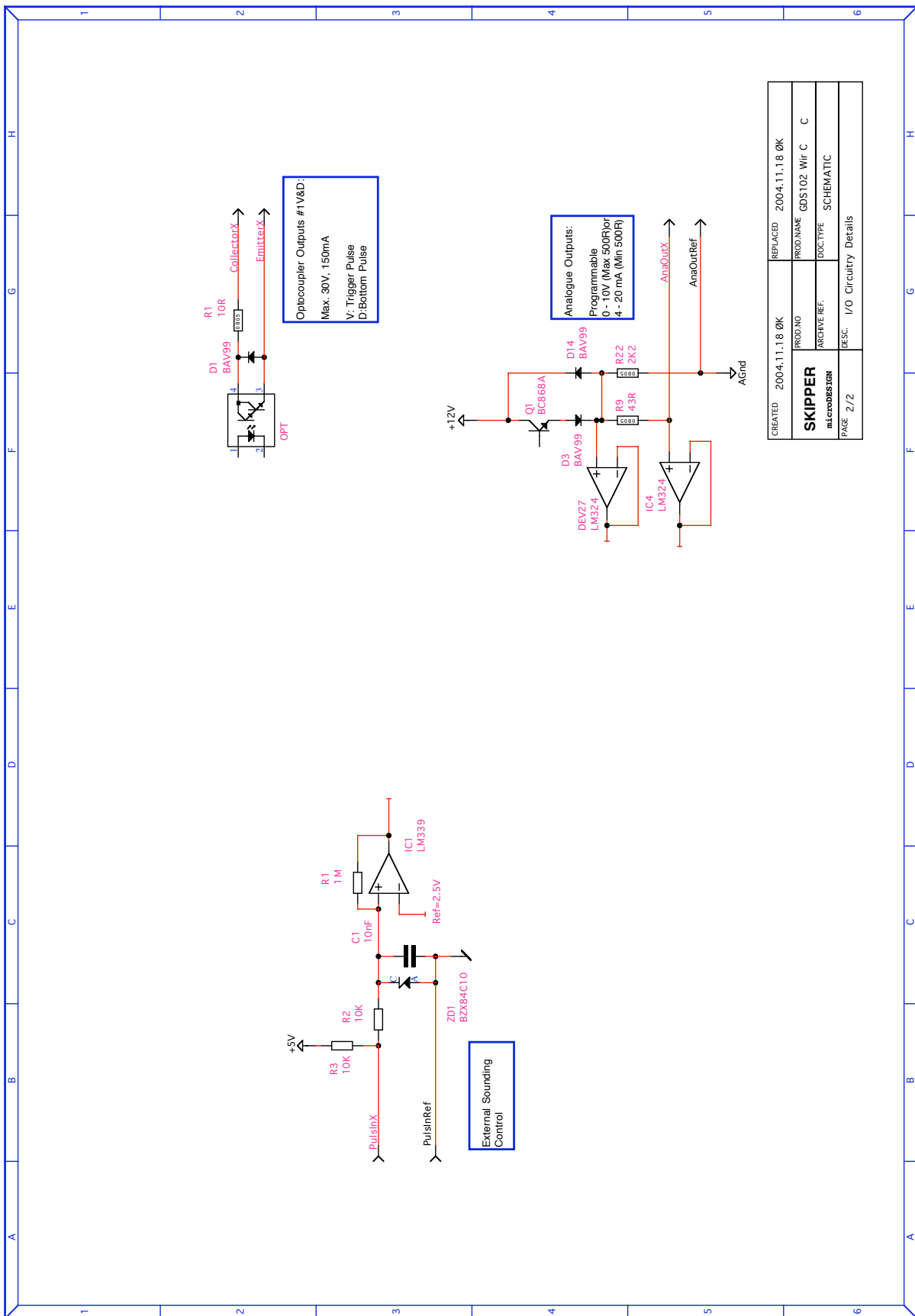

Fig. 3.9. Input/Output Circuitry 1

Input/Output Circuitry 2

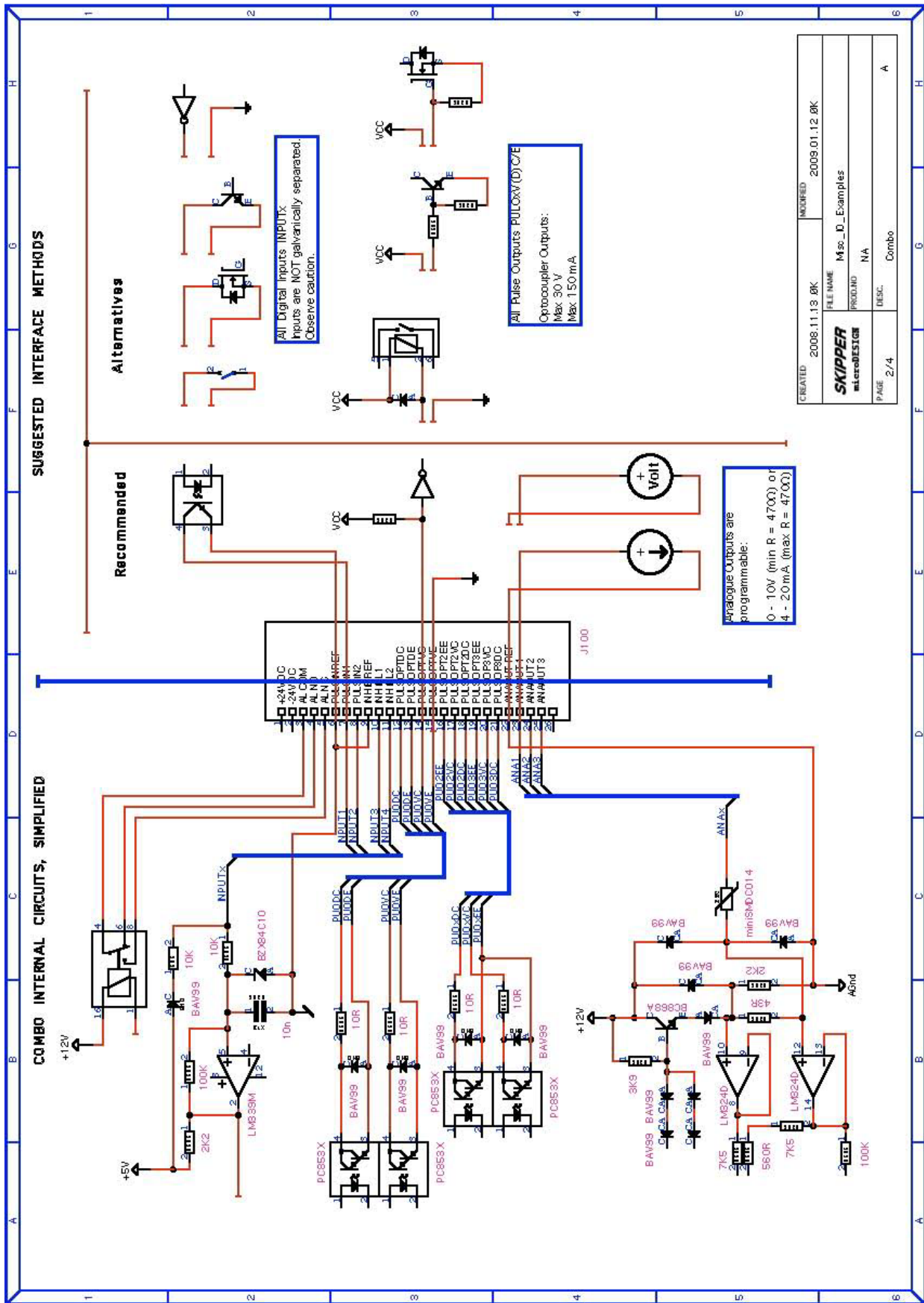

Fig. 3.10. Input/Output Circuitry 2

Input/Output Circuitry 3

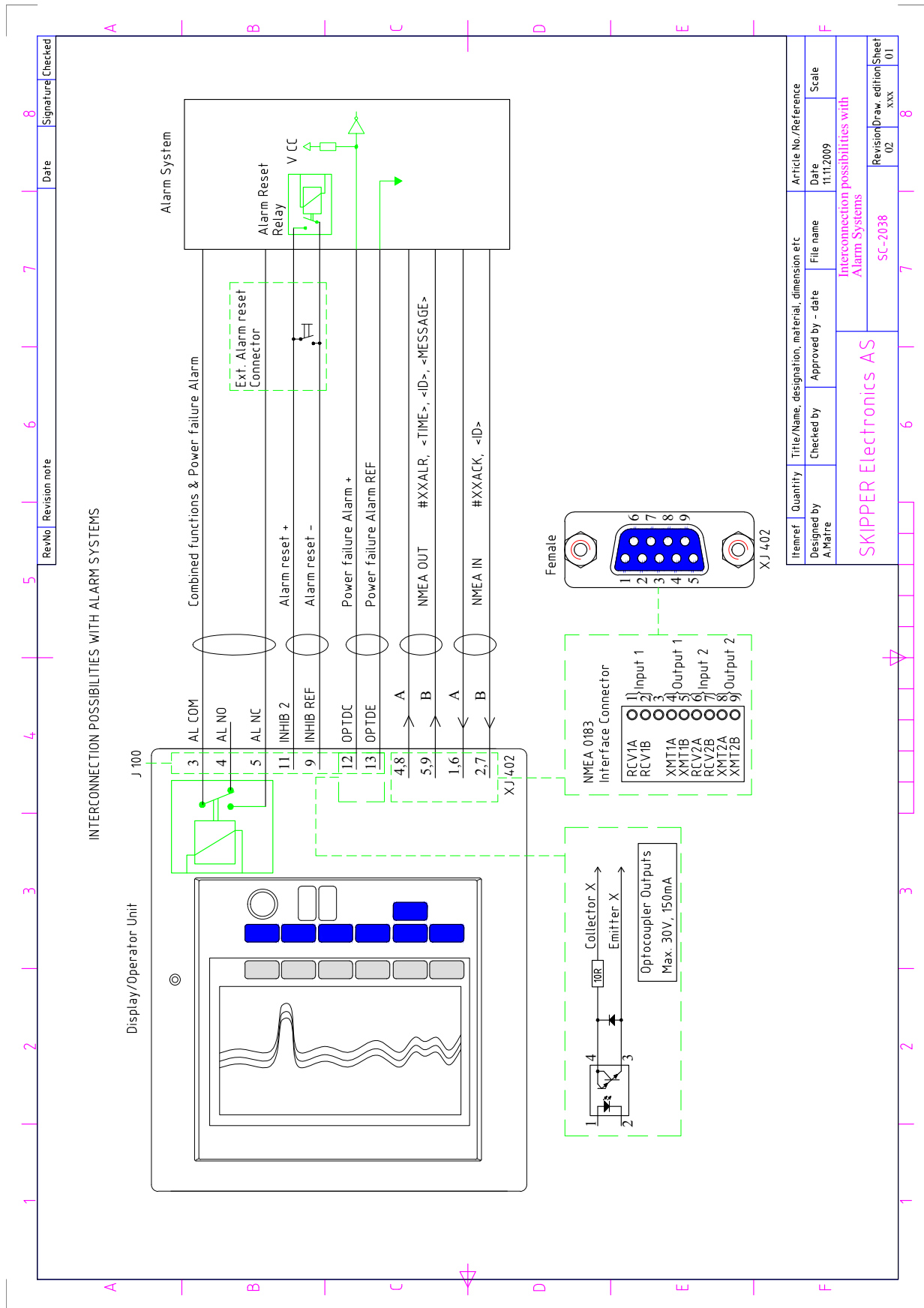

Fig. 3.11. Input/Output Circuitry 3

4. Start-up and system Adaption

System Adaptation

Primary channel assignment

Primary channel can be assigned in screen 4 (soft keys SELECT CHN and PRIMARY yes/no). In general this should be the channel with a transducer which has the most favorable operating properties (frequency, power etc.) and installation conditions. Depth value from the primary channel is always used for analogue outputs, NMEA 0183 standard sentences and alarm messages. See [“Fig. 2.5. Screen 4. Transducer details.” on page 16.](#)

Transducer installation position

The position of each transducer can be defined in screen 4, soft key LOCATION. The possible options are FWD (bow), AFT (aft the ship), PORT (portside) and STRB (starboard). This information will be indicated on the screen and used in SKIPPER proprietary NMEA sentences. If only one transducer is installed, it is **advisable** to select “not inst.” value for the second transducer. This will disable transmissions on this channel and the text line in the upper part of the screen will contain information (frequency and draught) about one channel only.

Screen presentation

The desirable screen presentation (vertical/horizontal screen split or single channel indication) can be selected in screen 2 (soft key DISPLAY, see [“Fig. 2.3. Screen 2. Display and print settings.” on page 14.](#)) In case of dual presentation, the position of the channels on the screen is also programmable and can be selected in screen 4 (soft key SCREEN POS, see [“Fig. 2.5. Screen 4. Transducer details.” on page 16.](#)) The size of the digital depth indicator can be selected in screen 2 by soft key DIGIT, see [“Fig. 2.3. Screen 2. Display and print settings.” on page 14.](#)

Alarm limits and local alarm buzzer control

Shallow and deep water alarm limits are adjustable in screen 1, see [“Fig. 2.2. Screen 1. Gain, TVG and alarm settings.” on page 13.](#) **Note:** The depth value measured at the **primary** channel is always used for alarm control function. The local audio alarm (internal buzzer) can be toggled in screen 11, see [“Fig. 2.12. Screen 11. System status screen.” on page 23.](#) Alarm relay and local audio alarm can be reset either locally (by pressing any key on the panel) or externally (alarm reset input or NMEA message), while the visual alarm indication can be reset only locally. The shallow alarm has a maximum of 99 m. The deep water alarm can be adjusted to the maximum depth (5000 m).

Analogue Outputs Range Selection

Shallow and deep water calibration limits for the analogue output may be set in screen 7, see [“Fig. 2.8. Screen 7. Interface setup screen.” on page 19.](#) ANA UPPER (default value 0 m) corresponds to 0 V (4 mA) on the output, while ANA LOWER (default value 50 m) corresponds to 10 V (20 mA). If the measured depth on the primary channel is exceeding ANA UPPER setting, 10 V (20 mA) is provided on the output.

Clock and calendar settings

Screen 5 is dedicated to the real-time clock and calendar adjustments, see [“Fig. 2.6. Screen 5. Calendar and clock setting.” on page 17.](#) **Note:** If time and date information is provided on NMEA inputs, this will be used by the sounder and the soft keys are not operative.

Language and Units of Measurement

In screen 6 it is possible to select different languages and units of measurement for the screen and printer. See “[Fig. 2.7. Screen 6. Units of measurement.](#)” on page 18. The available languages are: English, French, Spanish, German and Norwegian.

Units of measurement may be selected for:

- Depth: meters, feet, fathoms, braccias.
- Vessel speed: knots, km/h, miles/h.
- Sound speed: m/s, knots, km/h, mi/h, ft/s (feet/s)

NMEA Setup

Screen 10 is used for verification of received and control of transmitted NMEA messages. See “[Fig. 2.11. Screen 10. NMEA control screen.](#)” on page 22. Two communication ports (NMEA 0183) are provided:

1. XJ402, RCV1A/B - XMT1A/B
2. XJ402, RCV2A/B - XMT2A/B.

Each port can be programmed individually with respect to the baud rate and scope of transmitted messages. Before configuring the required channel, it must be selected with soft key NMEA PORT.

Note: The text window will represent information which corresponds to the currently selected port. The type of displayed messages received from external talker (if connected) or transmitted by the sounder, is selectable by using soft key DISPLAY. For more easy analysis of the window contents, display can be prevented from continuous update, if DISPLAY off is selected. The baud rate may be set to 4800 or 9600, 4800 being the more common. Transmitted messages are enabled individually by using a pair of soft keys, MESSAGE and STATUS. To enable/disable particular message, select it from the list by pressing MESSAGE button until required message appears on the same button and then select the status of this message (on/off) by pressing soft key STATUS. It is advisable at this stage to set DISPLAY to “output” mode, to be able to observe current scope of transmitted messages. Transmitted talker identifier is SD, Sounder Depth.

NMEA transmitted/output messages

Depth & Draught	SDDPT,xxxx.x,xxxx.x,xxxx.x*hh<CR><LF>
Depth below surface	SDDBS,xxxx.x,f,xxxx.x,M,xxx.x,F*hh<CR><LF>
Depth below transducer	SDDBT,xxxx.x,f,xxxx.x,M,xxx.x,F*hh<CR><LF>
Depth below keel	SDDBK,xxxx.x,f,xxxx.x,M,xxx.x,F*hh<CR><LF>
Set Alarm State	SDALR,hhmmss.ss,xxx,A,A,c--c*hh<CR><LF>

In case of multiple transducers installation the following SKIPPER proprietary sentence can be selected by enabling format SKP1 and/or SKP2.

SPSKPDPT,x.x,x.x,x.x,xx,xx,c--c*hh<CR><LF>

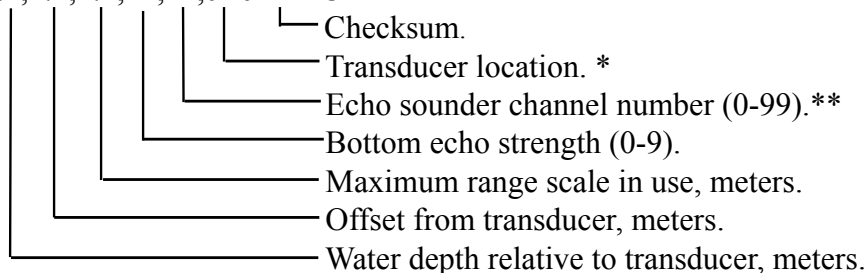

* Text string, indicating transducer position: FWD/AFT/PORT/STB. If position is not preset by operator, empty field is provided.

** = 1 (for SKP1) or 2 (for SKP2). **Note:** SKP1 format is presenting information, which is linked to the echo sounder channel 1, while SKP2 - to operating channel 2. Each of these two formats can be enabled/disabled individually.

NMEA received/input messages

The talker identifier is ignored.

Time

Universal time	ZZU,xxxxxx
Universal time & local	ZLZ,xxxxxx,xxxxxx,-xx
Day, month, year	ZDA,xxxxxx,xx,xx,xxxx,-xx

The time values will be indicated in the upper left corner of the screen, example: 11:43.

Position

Geographical lat/lon	GLL,xxxx.xx,N,xxxx.xx,W
Geographical fix, present	GXP,xxxxxx,xxxx.xx,N,xxxx.xx,W,cccc,x
Loran C fix, present	GLP,xxxxxx,xxxx.xx,N,xxxx.xx,W,cccc
GPS position	GGA,xxxxxx,xxxx.xxx,N,xxxx.xxx,W,x

The position values will be indicated on top of the screen, right side, example: E059° 13.12' N010° 57.34'.

Heading

Heading, true, present	HDT,xxx.,T
Heading, magnetic, present	HDM,xxx.,M
Heading, compass	HCC,xxx.
True heading and status	THS,x.x,a*hh<CR><LF>

The heading values will be indicated on top of the screen, right side, example: 123.0°.

Alarm

Acknowledge alarm	ACK,xxx*hh<CR><LF>
-------------------	--------------------

Speed

Dual ground/water speed	VBW,xx.xx,Axx.xx,a,uxx.xx,uxx.xx,a
-------------------------	------------------------------------

The speed value will be indicated on top of the screen, right side, example: 15.55 kts.

Composite

Loran C specific	RMA,a,xxxx.xx,N,xxxx.xx,W,,xx.x,xxx.,*xx
GPS, transit specific	RMC,xxxxxx,a,xxxx.xx,N,xxxx.xx,W,xx.x,xxx.,xxxxxx,*xx
Track and ground speed	VTG,xxx.,T,xxx.,M,xx.x,N,xx.x,K
Heading and water speed	VHW,xxx.,T,xxx.,M,xx.x,N,xx.x,K

The composite values will be indicated on different positions on top of the screen, depending on message type.

9 Pin D-SUB (female connector) in cabinet front seen from outside.

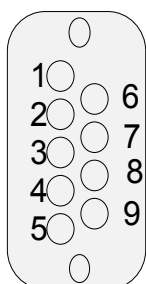

NMEA IN: Pin 1-2, RCV1 A, B
 NMEA IN: Pin 6-7, RCV2 A, B
 NMEA OUT: Pin 4-5, XMT1 A, B
 NMEA OUT: Pin 8-9, XMT2 A, B

Fig. 4.1. NMEA connector XJ402.

Frequency setup

The frequencies of both channels are preset in production. It is possible to change the settings. To do so, it is necessary to set the required values on the DIP switches on the dual transceiver PCB, according to table 4.3 **and** adjust the displaying value on screen 4 (soft key FREQUENCY) see “[Fig. 2.5. Screen 4. Transducer details.](#)” on page 16. **Note: Both must be adjusted, as adjusting just the indicated values will not change the actual operating frequency.**

- **Channel 1** is optimized for frequencies **50 - 265 kHz**. The required frequency must be set using jumper **SW3** on the transceiver PCB according to table 4.3. **Note:** The factory setting is 200 kHz.
- **Channel 2** is optimized for frequencies **10 - 50 kHz**. Required frequency must be set by jumper **SW2** on the dual transceiver PCB according to table 4.3. **Note:** The factory setting is 50 kHz.

SW2 and SW3 are located in the upper right corner of the transceiver PCB, (see fig. 4.2 below). Transducers must be connected to the corresponding terminals.

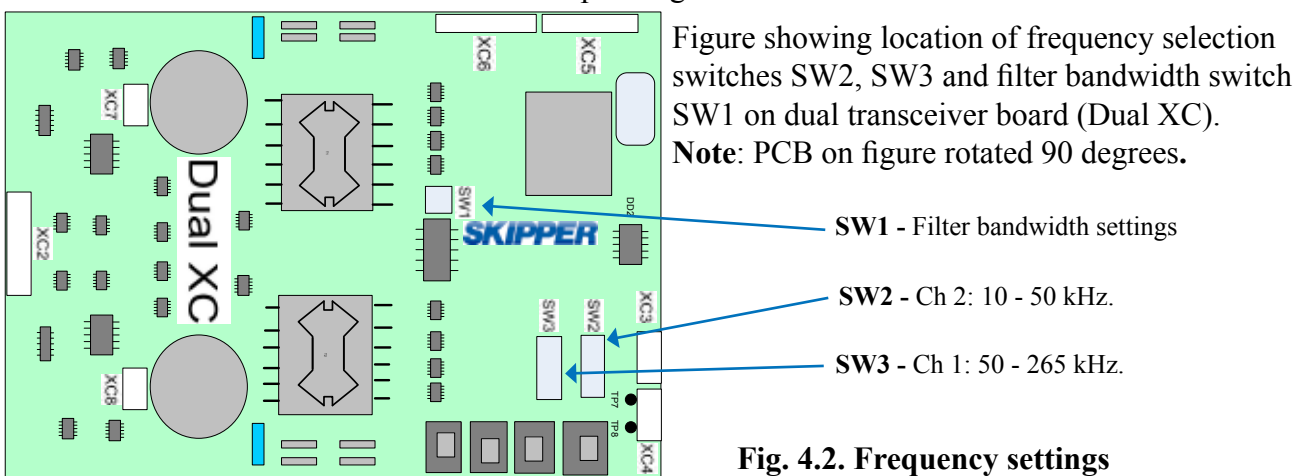

Fig. 4.2. Frequency settings

Filter setup

SW1 selects the filter bandwidth according to the following values:

1	2	Bandwidth
Off	Off	1 kHz
Off	On	2 kHz
On	Off	4 kHz (default value)
On	On	8 kHz

Figure is showing default value for SW1. (See fig. 4.2 for location on PCB).

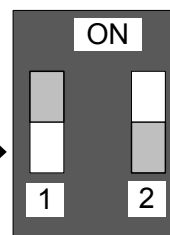

Important: Do not change default value before consulting Skipper.

Fig. 4.3. SW1 bandwidth settings

Important

When doing service or repair, please wait two minutes after power off, before unplugging internal connectors.

Table 4.3 Frequency DIP switch settings, SW3 for Ch 1 (50 - 265 kHz), SW2 for Ch 2 (10 - 50 kHz)
Frequency SW2/SW3 settings

Frequency (kHz)	Dip 1	Dip 2	Dip 3	Dip 4	Dip 5	Dip 6	Dip 7	Dip 8
10	ON	ON	ON	ON	ON	ON	ON	ON
11	OFF	ON	ON	ON	ON	ON	ON	ON
12	ON	OFF	ON	ON	ON	ON	ON	ON
13	OFF	OFF	ON	ON	ON	ON	ON	ON
14	ON	ON	OFF	ON	ON	ON	ON	ON
15	OFF	ON	OFF	ON	ON	ON	ON	ON
16	ON	OFF	OFF	ON	ON	ON	ON	ON
17	OFF	OFF	OFF	ON	ON	ON	ON	ON
18	ON	ON	ON	OFF	ON	ON	ON	ON
19	OFF	ON	ON	OFF	ON	ON	ON	ON
20	ON	OFF	ON	OFF	ON	ON	ON	ON
21	OFF	OFF	ON	OFF	ON	ON	ON	ON
22	ON	ON	OFF	OFF	ON	ON	ON	ON
23	OFF	ON	OFF	OFF	ON	ON	ON	ON
24	ON	OFF	OFF	OFF	ON	ON	ON	ON
25	OFF	OFF	OFF	OFF	ON	ON	ON	ON
26	ON	ON	ON	ON	OFF	ON	ON	ON
27	OFF	ON	ON	ON	OFF	ON	ON	ON
28	ON	OFF	ON	ON	OFF	ON	ON	ON
29	OFF	OFF	ON	ON	OFF	ON	ON	ON
30	ON	ON	OFF	ON	OFF	ON	ON	ON
31	OFF	ON	OFF	ON	OFF	ON	ON	ON
32	ON	OFF	OFF	ON	OFF	ON	ON	ON
33	OFF	OFF	OFF	ON	OFF	ON	ON	ON
34	ON	ON	ON	OFF	OFF	ON	ON	ON
35	OFF	ON	ON	OFF	OFF	ON	ON	ON
36	ON	OFF	ON	OFF	OFF	ON	ON	ON
37	OFF	OFF	ON	OFF	OFF	ON	ON	ON
38	ON	ON	OFF	OFF	OFF	ON	ON	ON
39	OFF	ON	OFF	OFF	OFF	ON	ON	ON
40	ON	OFF	OFF	OFF	OFF	ON	ON	ON
41	OFF	OFF	OFF	OFF	OFF	ON	ON	ON
42	ON	ON	ON	ON	ON	OFF	ON	ON
43	OFF	ON	ON	ON	ON	OFF	ON	ON
44	ON	OFF	ON	ON	ON	OFF	ON	ON
45	OFF	OFF	ON	ON	ON	OFF	ON	ON
46	ON	ON	OFF	ON	ON	OFF	ON	ON
47	OFF	ON	OFF	ON	ON	OFF	ON	ON
48	ON	OFF	OFF	ON	ON	OFF	ON	ON
49	OFF	OFF	OFF	ON	ON	OFF	ON	ON
50	ON	ON	ON	OFF	ON	OFF	ON	ON
51	OFF	ON	ON	OFF	ON	OFF	ON	ON
52	ON	OFF	ON	OFF	ON	OFF	ON	ON
53	OFF	OFF	ON	OFF	ON	OFF	ON	ON
54	ON	ON	OFF	OFF	ON	OFF	ON	ON

Table 4.3 Frequency DIP switch settings, SW3 for Ch 1 (50 - 265 kHz), SW2 for Ch 2 (10 - 50 kHz)
Frequency SW2/SW3 settings

Frequency (kHz)	Dip 1	Dip 2	Dip 3	Dip 4	Dip 5	Dip 6	Dip 7	Dip 8
55	OFF	ON	OFF	OFF	ON	OFF	ON	ON
56	ON	OFF	OFF	OFF	ON	OFF	ON	ON
57	OFF	OFF	OFF	OFF	ON	OFF	ON	ON
58	ON	ON	ON	ON	OFF	OFF	ON	ON
59	OFF	ON	ON	ON	OFF	OFF	ON	ON
60	ON	OFF	ON	ON	OFF	OFF	ON	ON
61	OFF	OFF	ON	ON	OFF	OFF	ON	ON
62	ON	ON	OFF	ON	OFF	OFF	ON	ON
63	OFF	ON	OFF	ON	OFF	OFF	ON	ON
64	ON	OFF	OFF	ON	OFF	OFF	ON	ON
65	OFF	OFF	OFF	ON	OFF	OFF	ON	ON
66	ON	ON	ON	OFF	OFF	OFF	ON	ON
67	OFF	ON	ON	OFF	OFF	OFF	ON	ON
68	ON	OFF	ON	OFF	OFF	OFF	ON	ON
69	OFF	OFF	ON	OFF	OFF	OFF	ON	ON
70	ON	ON	OFF	OFF	OFF	OFF	ON	ON
71	OFF	ON	OFF	OFF	OFF	OFF	ON	ON
72	ON	OFF	OFF	OFF	OFF	OFF	ON	ON
73	OFF	OFF	OFF	OFF	OFF	OFF	ON	ON
74	ON	ON	ON	ON	ON	ON	OFF	ON
75	OFF	ON	ON	ON	ON	ON	OFF	ON
76	ON	OFF	ON	ON	ON	ON	OFF	ON
77	OFF	OFF	ON	ON	ON	ON	OFF	ON
78	ON	ON	OFF	ON	ON	ON	OFF	ON
79	OFF	ON	OFF	ON	ON	ON	OFF	ON
80	ON	OFF	OFF	ON	ON	ON	OFF	ON
81	OFF	OFF	OFF	ON	ON	ON	OFF	ON
82	ON	ON	ON	OFF	ON	ON	OFF	ON
83	OFF	ON	ON	OFF	ON	ON	OFF	ON
84	ON	OFF	ON	OFF	ON	ON	OFF	ON
85	OFF	OFF	ON	OFF	ON	ON	OFF	ON
86	ON	ON	OFF	OFF	ON	ON	OFF	ON
87	OFF	ON	OFF	OFF	ON	ON	OFF	ON
88	ON	OFF	OFF	OFF	ON	ON	OFF	ON
89	OFF	OFF	OFF	OFF	ON	ON	OFF	ON
90	ON	ON	ON	ON	OFF	ON	OFF	ON
91	OFF	ON	ON	ON	OFF	ON	OFF	ON
92	ON	OFF	ON	ON	OFF	ON	OFF	ON
93	OFF	OFF	ON	ON	OFF	ON	OFF	ON
94	ON	ON	OFF	ON	OFF	ON	OFF	ON
95	OFF	ON	OFF	ON	OFF	ON	OFF	ON
96	ON	OFF	OFF	ON	OFF	ON	OFF	ON
97	OFF	OFF	OFF	ON	OFF	ON	OFF	ON
98	ON	ON	ON	OFF	OFF	ON	OFF	ON
99	OFF	ON	ON	OFF	OFF	ON	OFF	ON

Table 4.3 Frequency DIP switch settings, SW3 for Ch 1 (50 - 265 kHz), SW2 for Ch 2 (10 - 50 kHz)**Frequency SW2/SW3 settings**

Frequency (kHz)	Dip 1	Dip 2	Dip 3	Dip 4	Dip 5	Dip 6	Dip 7	Dip 8
100	ON	OFF	ON	OFF	OFF	ON	OFF	ON
101	OFF	OFF	ON	OFF	OFF	ON	OFF	ON
102	ON	ON	OFF	OFF	OFF	ON	OFF	ON
103	OFF	ON	OFF	OFF	OFF	ON	OFF	ON
104	ON	OFF	OFF	OFF	OFF	ON	OFF	ON
105	OFF	OFF	OFF	OFF	OFF	ON	OFF	ON
106	ON	ON	ON	ON	ON	OFF	OFF	ON
107	OFF	ON	ON	ON	ON	OFF	OFF	ON
108	ON	OFF	ON	ON	ON	OFF	OFF	ON
109	OFF	OFF	ON	ON	ON	OFF	OFF	ON
110	ON	ON	OFF	ON	ON	OFF	OFF	ON
111	OFF	ON	OFF	ON	ON	OFF	OFF	ON
112	ON	OFF	OFF	ON	ON	OFF	OFF	ON
113	OFF	OFF	OFF	ON	ON	OFF	OFF	ON
114	ON	ON	ON	OFF	ON	OFF	OFF	ON
115	OFF	ON	ON	OFF	ON	OFF	OFF	ON
116	ON	OFF	ON	OFF	ON	OFF	OFF	ON
117	OFF	OFF	ON	OFF	ON	OFF	OFF	ON
118	ON	ON	OFF	OFF	ON	OFF	OFF	ON
119	OFF	ON	OFF	OFF	ON	OFF	OFF	ON
120	ON	OFF	OFF	OFF	ON	OFF	OFF	ON
121	OFF	OFF	OFF	OFF	ON	OFF	OFF	ON
122	ON	ON	ON	ON	OFF	OFF	OFF	ON
123	OFF	ON	ON	ON	OFF	OFF	OFF	ON
124	ON	OFF	ON	ON	OFF	OFF	OFF	ON
125	OFF	OFF	ON	ON	OFF	OFF	OFF	ON
126	ON	ON	OFF	ON	OFF	OFF	OFF	ON
127	OFF	ON	OFF	ON	OFF	OFF	OFF	ON
128	ON	OFF	OFF	ON	OFF	OFF	OFF	ON
129	OFF	OFF	OFF	ON	OFF	OFF	OFF	ON
130	ON	ON	ON	OFF	OFF	OFF	OFF	ON
131	OFF	ON	ON	OFF	OFF	OFF	OFF	ON
132	ON	OFF	ON	OFF	OFF	OFF	OFF	ON
133	OFF	OFF	ON	OFF	OFF	OFF	OFF	ON
134	ON	ON	OFF	OFF	OFF	OFF	OFF	ON
135	OFF	ON	OFF	OFF	OFF	OFF	OFF	ON
136	ON	OFF	OFF	OFF	OFF	OFF	OFF	ON
137	OFF	OFF	OFF	OFF	OFF	OFF	OFF	ON
138	ON	ON	ON	ON	ON	ON	ON	OFF
139	OFF	ON	ON	ON	ON	ON	ON	OFF
140	ON	OFF	ON	ON	ON	ON	ON	OFF
141	OFF	OFF	ON	ON	ON	ON	ON	OFF

Table 4.3 Frequency DIP switch settings, SW3 for Ch 1 (50 - 265 kHz), SW2 for Ch 2 (10 - 50 kHz)**Frequency SW2/SW3 settings**

Frequency (kHz)	Dip 1	Dip 2	Dip 3	Dip 4	Dip 5	Dip 6	Dip 7	Dip 8
142	ON	ON	OFF	ON	ON	ON	ON	OFF
143	OFF	ON	OFF	ON	ON	ON	ON	OFF
144	ON	OFF	OFF	ON	ON	ON	ON	OFF
145	OFF	OFF	OFF	ON	ON	ON	ON	OFF
146	ON	ON	ON	OFF	ON	ON	ON	OFF
147	OFF	ON	ON	OFF	ON	ON	ON	OFF
148	ON	OFF	ON	OFF	ON	ON	ON	OFF
149	OFF	OFF	ON	OFF	ON	ON	ON	OFF
150	ON	ON	OFF	OFF	ON	ON	ON	OFF
151	OFF	ON	OFF	OFF	ON	ON	ON	OFF
152	ON	OFF	OFF	OFF	ON	ON	ON	OFF
153	OFF	OFF	OFF	OFF	ON	ON	ON	OFF
154	ON	ON	ON	ON	OFF	ON	ON	OFF
155	OFF	ON	ON	ON	OFF	ON	ON	OFF
156	ON	OFF	ON	ON	OFF	ON	ON	OFF
157	OFF	OFF	ON	ON	OFF	ON	ON	OFF
158	ON	ON	OFF	ON	OFF	ON	ON	OFF
159	OFF	ON	OFF	ON	OFF	ON	ON	OFF
160	ON	OFF	OFF	ON	OFF	ON	ON	OFF
161	OFF	OFF	OFF	ON	OFF	ON	ON	OFF
162	ON	ON	ON	OFF	OFF	ON	ON	OFF
163	OFF	ON	ON	OFF	OFF	ON	ON	OFF
164	ON	OFF	ON	OFF	OFF	ON	ON	OFF
165	OFF	OFF	ON	OFF	OFF	ON	ON	OFF
166	ON	ON	OFF	OFF	OFF	ON	ON	OFF
167	OFF	ON	OFF	OFF	OFF	ON	ON	OFF
168	ON	OFF	OFF	OFF	OFF	ON	ON	OFF
169	OFF	OFF	OFF	OFF	OFF	ON	ON	OFF
170	ON	ON	ON	ON	ON	OFF	ON	OFF
171	OFF	ON	ON	ON	ON	OFF	ON	OFF
172	ON	OFF	ON	ON	ON	OFF	ON	OFF
173	OFF	OFF	ON	ON	ON	OFF	ON	OFF
174	ON	ON	OFF	ON	ON	OFF	ON	OFF
175	OFF	ON	OFF	ON	ON	OFF	ON	OFF
176	ON	OFF	OFF	ON	ON	OFF	ON	OFF
177	OFF	OFF	OFF	ON	ON	OFF	ON	OFF
178	ON	ON	ON	OFF	ON	OFF	ON	OFF
179	OFF	ON	ON	OFF	ON	OFF	ON	OFF
180	ON	OFF	ON	OFF	ON	OFF	ON	OFF
181	OFF	OFF	ON	OFF	ON	OFF	ON	OFF
182	ON	ON	OFF	OFF	ON	OFF	ON	OFF
183	OFF	ON	OFF	OFF	ON	OFF	ON	OFF

Table 4.3 Frequency DIP switch settings, SW3 for Ch 1 (50 - 265 kHz), SW2 for Ch 2 (10 - 50 kHz)
Frequency SW2/SW3 settings

Frequency (kHz)	Dip 1	Dip 2	Dip 3	Dip 4	Dip 5	Dip 6	Dip 7	Dip 8
184	ON	OFF	OFF	OFF	ON	OFF	ON	OFF
185	OFF	OFF	OFF	OFF	ON	OFF	ON	OFF
186	ON	ON	ON	ON	OFF	OFF	ON	OFF
187	OFF	ON	ON	ON	OFF	OFF	ON	OFF
188	ON	OFF	ON	ON	OFF	OFF	ON	OFF
189	OFF	OFF	ON	ON	OFF	OFF	ON	OFF
190	ON	ON	OFF	ON	OFF	OFF	ON	OFF
191	OFF	ON	OFF	ON	OFF	OFF	ON	OFF
192	ON	OFF	OFF	ON	OFF	OFF	ON	OFF
193	OFF	OFF	OFF	ON	OFF	OFF	ON	OFF
194	ON	ON	ON	OFF	OFF	OFF	ON	OFF
195	OFF	ON	ON	OFF	OFF	OFF	ON	OFF
196	ON	OFF	ON	OFF	OFF	OFF	ON	OFF
197	OFF	OFF	ON	OFF	OFF	OFF	ON	OFF
198	ON	ON	OFF	OFF	OFF	OFF	ON	OFF
199	OFF	ON	OFF	OFF	OFF	OFF	ON	OFF
200	ON	OFF	OFF	OFF	OFF	OFF	ON	OFF
201	OFF	OFF	OFF	OFF	OFF	OFF	ON	OFF
202	ON	ON	ON	ON	ON	ON	OFF	OFF
203	OFF	ON	ON	ON	ON	ON	OFF	OFF
204	ON	OFF	ON	ON	ON	ON	OFF	OFF
205	OFF	OFF	ON	ON	ON	ON	OFF	OFF
206	ON	ON	OFF	ON	ON	ON	OFF	OFF
207	OFF	ON	OFF	ON	ON	ON	OFF	OFF
208	ON	OFF	OFF	ON	ON	ON	OFF	OFF
209	OFF	OFF	OFF	ON	ON	ON	OFF	OFF
210	ON	ON	ON	OFF	ON	ON	OFF	OFF
211	OFF	ON	ON	OFF	ON	ON	OFF	OFF
212	ON	OFF	ON	OFF	ON	ON	OFF	OFF
213	OFF	OFF	ON	OFF	ON	ON	OFF	OFF
214	ON	ON	OFF	OFF	ON	ON	OFF	OFF
215	OFF	ON	OFF	OFF	ON	ON	OFF	OFF
216	ON	OFF	OFF	OFF	ON	ON	OFF	OFF
217	OFF	OFF	OFF	OFF	ON	ON	OFF	OFF
218	ON	ON	ON	ON	OFF	ON	OFF	OFF
219	OFF	ON	ON	ON	OFF	ON	OFF	OFF
220	ON	OFF	ON	ON	OFF	ON	OFF	OFF
221	OFF	OFF	ON	ON	OFF	ON	OFF	OFF
222	ON	ON	OFF	ON	OFF	ON	OFF	OFF
223	OFF	ON	OFF	ON	OFF	ON	OFF	OFF
224	ON	OFF	OFF	ON	OFF	ON	OFF	OFF
225	OFF	OFF	OFF	ON	OFF	ON	OFF	OFF

Table 4.3 Frequency DIP switch settings, SW3 for Ch 1 (50 - 265 kHz), SW2 for Ch 2 (10 - 50 kHz)
Frequency SW2/SW3 settings

Frequency (kHz)	Dip 1	Dip 2	Dip 3	Dip 4	Dip 5	Dip 6	Dip 7	Dip 8
226	ON	ON	ON	OFF	OFF	ON	OFF	OFF
227	OFF	ON	ON	OFF	OFF	ON	OFF	OFF
228	ON	OFF	ON	OFF	OFF	ON	OFF	OFF
229	OFF	OFF	ON	OFF	OFF	ON	OFF	OFF
230	ON	ON	OFF	OFF	OFF	ON	OFF	OFF
231	OFF	ON	OFF	OFF	OFF	ON	OFF	OFF
232	ON	OFF	OFF	OFF	OFF	ON	OFF	OFF
233	OFF	OFF	OFF	OFF	OFF	ON	OFF	OFF
234	ON	ON	ON	ON	ON	OFF	OFF	OFF
235	OFF	ON	ON	ON	ON	OFF	OFF	OFF
236	ON	OFF	ON	ON	ON	OFF	OFF	OFF
237	OFF	OFF	ON	ON	ON	OFF	OFF	OFF
238	ON	ON	OFF	ON	ON	OFF	OFF	OFF
239	OFF	ON	OFF	ON	ON	OFF	OFF	OFF
240	ON	OFF	OFF	ON	ON	OFF	OFF	OFF
241	OFF	OFF	OFF	ON	ON	OFF	OFF	OFF
242	ON	ON	ON	OFF	ON	OFF	OFF	OFF
243	OFF	ON	ON	OFF	ON	OFF	OFF	OFF
244	ON	OFF	ON	OFF	ON	OFF	OFF	OFF
245	OFF	OFF	ON	OFF	ON	OFF	OFF	OFF
246	ON	ON	OFF	OFF	ON	OFF	OFF	OFF
247	OFF	ON	OFF	OFF	ON	OFF	OFF	OFF
248	ON	OFF	OFF	OFF	ON	OFF	OFF	OFF
249	OFF	OFF	OFF	OFF	ON	OFF	OFF	OFF
250	ON	ON	ON	ON	OFF	OFF	OFF	OFF
251	OFF	ON	ON	ON	OFF	OFF	OFF	OFF
252	ON	OFF	ON	ON	OFF	OFF	OFF	OFF
253	OFF	OFF	ON	ON	OFF	OFF	OFF	OFF
254	ON	ON	OFF	ON	OFF	OFF	OFF	OFF
255	OFF	ON	OFF	ON	OFF	OFF	OFF	OFF
256	ON	OFF	OFF	ON	OFF	OFF	OFF	OFF
257	OFF	OFF	OFF	ON	OFF	OFF	OFF	OFF
258	ON	ON	ON	OFF	OFF	OFF	OFF	OFF
259	OFF	ON	ON	OFF	OFF	OFF	OFF	OFF
260	ON	OFF	ON	OFF	OFF	OFF	OFF	OFF
261	OFF	OFF	ON	OFF	OFF	OFF	OFF	OFF
262	ON	ON	OFF	OFF	OFF	OFF	OFF	OFF
263	OFF	ON	OFF	OFF	OFF	OFF	OFF	OFF
264	ON	OFF	OFF	OFF	OFF	OFF	OFF	OFF
265	OFF	OFF	OFF	OFF	OFF	OFF	OFF	OFF

Options

Calibration, sound speed

The only possible calibration activity is when the sound speed option is installed. In this case, set the required sound speed value on screen 3. See [“Fig. 2.4. Screen 3. Power adjustment and options.” on page 15.](#)

Remote Sounding Control

When this option is installed, transmitter operation may be controlled by the external signal. The active polarity of this signal may be set on screen 7, see [“Fig. 2.8. Screen 7. Interface setup screen.” on page 19.](#) The following function options are available on screen 3, see [“Fig. 2.4. Screen 3. Power adjustment and options.” on page 15:](#)

Ping

Name	Description
Continuous	Transmitter operation is continuous and not affected by the external signal.
Edge	The transmitter is activated <u>once</u> by an active signal edge. External Control will replace pict(ure) speed value in the screen to indicate that edge ping is enabled.
Level	The transmitter is controlled by the external signal level. An active level keeps the transmitter running, a passive level stops the transmitter. (L) will be added behind pict(ure) speed value in the screen to indicate that level ping is enabled.
Manual (single)	The transmitter is activated ping by ping by pressing the PICTURE SPEED button on the operator panel. The external control signal is disabled. Manual Control will replace pict(ure) speed value in the screen to indicate that manual ping is enabled.

Note: When the GDS102S remote sounding control option is in Edge, Level or Manual (single) mode, it is possible to silent the sounder by setting appropriate level on the TX control input (PULSE2/PULSEREF) on the Combo Terminal board. The visible alarm presentation on the screen is done by changing the colour of the digital depth value from black to red. As soon as transmissions are re-enabled, the colour will change to black again.



Picture showing depth in “non-transmitting” mode.

5. Trouble shooting

If it is possible to cycle through the screens and view information, several assumptions may be made regarding operation of the GDS102 system. Although some of the subsystems necessary for this basic system operation may still suffer from minor or intermittent operation disorders, the fact that it is possible to select and observe different presentation screens, indicate correct operation of the following GDS102 subsystems:

- The CPU board is operating.
- The keyboard interface board is working.
- The LCD and backlight inverter PCB are working.
- The keyboard interface part of the I/O board is working.
- The power supplies on the terminal board are basically working.

Status Screen (screen 11) diagnosis

Symptom	Cause	Remedy
Main voltages outside (acceptable range) <ul style="list-style-type: none"> • +5 V CPU: <> (4.7 V - 5.3 V) • +5 V IO: <> (4.7 V - 5.3 V) • +12 V CPU: <> (11.3 V - 12.7 V) • +12 V IO: <> (11.3 V - 12.7 V) • -12 V: <> (-11.3 V - -12.7 V) • HIGH V: <> (128 V - 136 V) 	<ul style="list-style-type: none"> • CPU or I/O PCB problem. • Terminal PCB problem. • CPU problem. • Transceiver PCB problem. • Terminal PCB problem. • Interconnect problem. • Defect power supply. 	<ul style="list-style-type: none"> • Replace CPU or I/O PCB. • Replace terminal PCB. • Replace CPU. • Replace transceiver PCB. • Replace terminal PCB. • Check connections between terminal PCB and transceiver PCB. • Replace transceiver board and/or terminal board.

High voltage measurement.

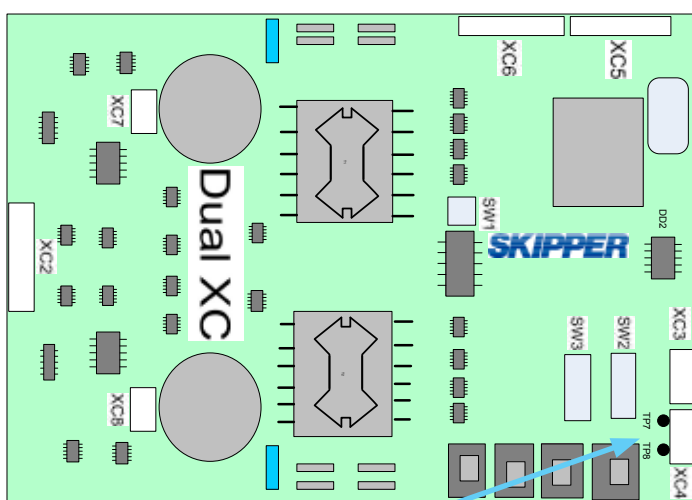

TP7 and TP8 Testpoint (TP) location for power reduction measurement.

Checking the high voltage/power reduction:

- Use a multimeter and measure the DC voltage in TP 7 and TP 8 on Dual transceiver PCB.

Power (%)	Expected voltage (V) range. Channel 1 (TP 8). Channel 2 (TP 7).
10 %	13 - 15 V
50 %	61 - 65 V
100 %	123 - 128 V

Note:

- When measuring, if possible, use the hold/ autohold function on the multimeter.
- These voltages are measured with a simulator connected to the output, and should only be regarded as guidelines for voltages with a transducer installed.

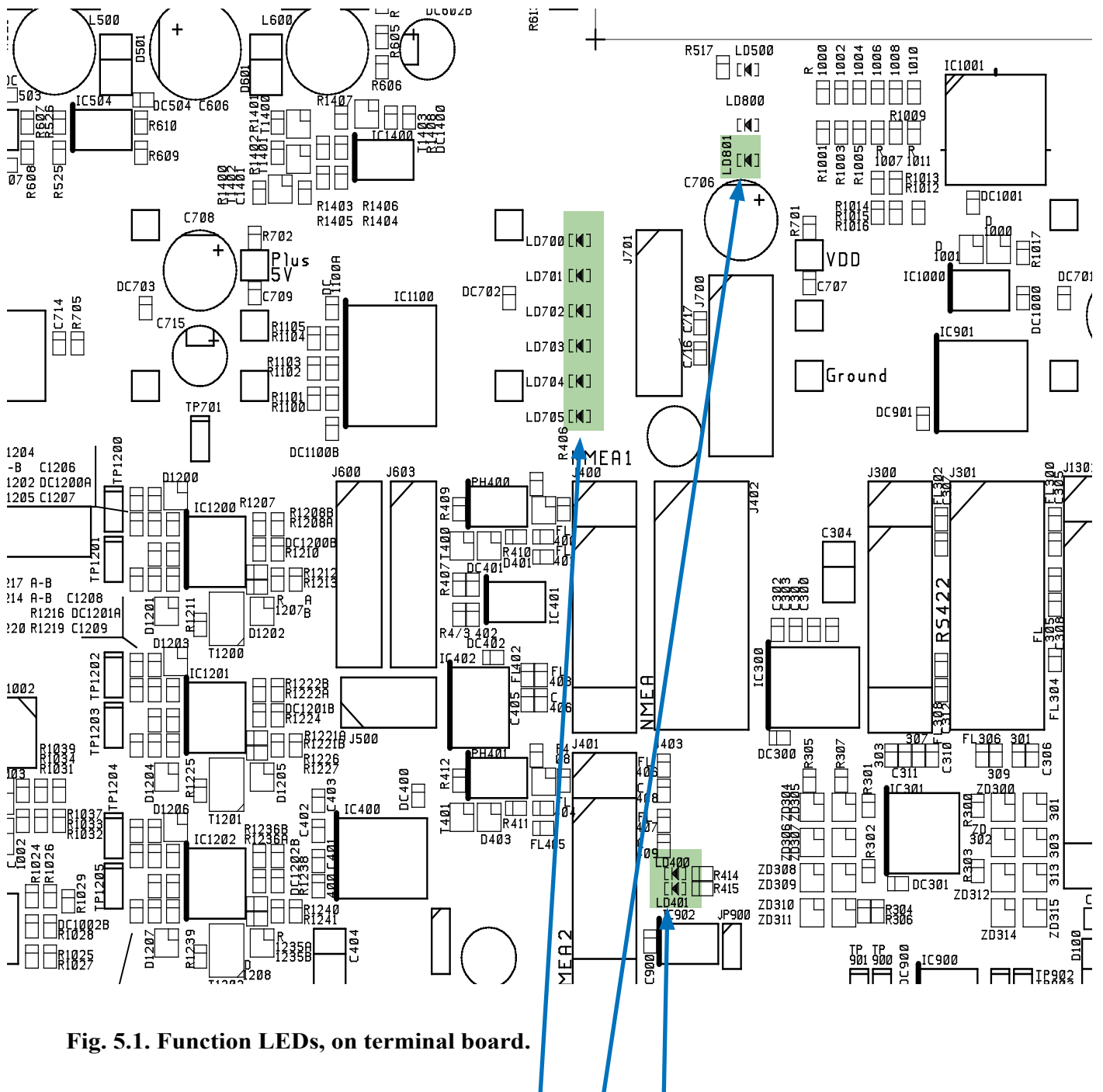

Fig. 5.1. Function LEDs, on terminal board.

Function LEDs.

The following LEDs are located on the terminal board as shown in fig 5.1:

- LD400 NMEA signal activity on receive input 1.
- LD401 NMEA signal activity on receive input 2.
- LD700: +5 V#1/VCC (5 V CPU, Board External and CPU).
- LD701: +12 V#1/VDD (12 V CPU, Board External).
- LD702: +5 V#2 (5V IO, Board Internal).
- LD703: +12 V#2 (Board Internal).
- LD704: -12 V.
- LD705: -5 V.
- LD801: High voltage to dual transceiver PCB.

Typical Status Screen 11 Contents

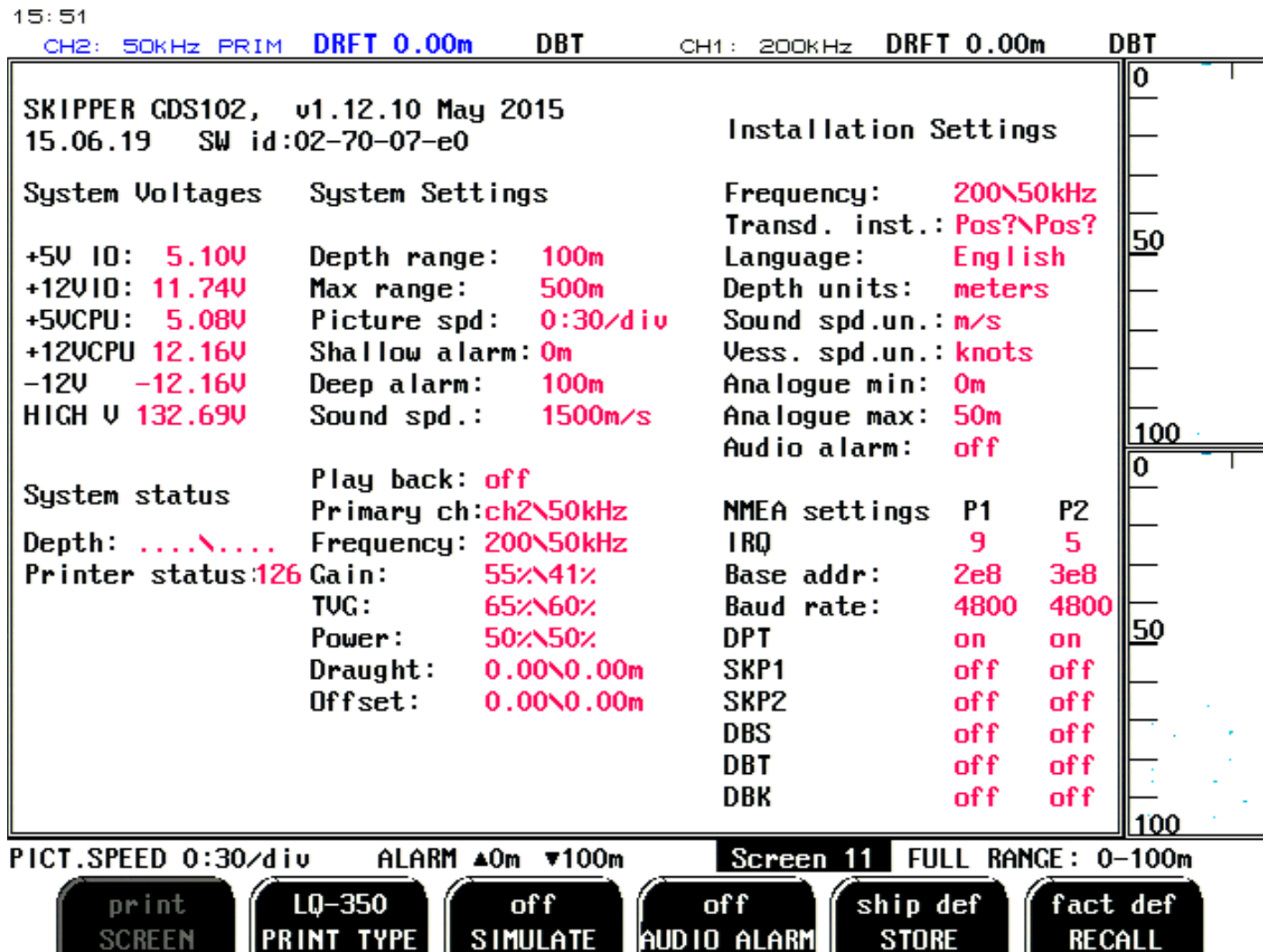

The status screen 11 contains information that will facilitate analysis and correction of several problems. A printout or picture of the status and oscilloscope screens should be sent with any report about functional disturbance. This will greatly facilitate remote failure analysis.

The other information on the status screen is a collection of information which may be observed and manipulated with the various screen soft key selections. As a reference, it will often be more convenient to observe the various settings together on this screen, than to cycle from screen to screen to check on the soft key texts.

Dual numbers (50 %/50 %) refers to channels (Ch 1/Ch 2).

Symptom	Cause	Remedy
Basic system integrity		
1. No picture on LCD Screen.	<ol style="list-style-type: none"> No AC or DC power to the system. System is in standby. To low screen backlight. Defective LCD module. Voltage(s) out of range. 	<ol style="list-style-type: none"> Check switches and fuses on the terminal PCB inside the GDS102 cabinet. Press any button on panel. Increase backlight setting. Replace module. Replace terminal PCB.
1. Picture is difficult to read.	<ol style="list-style-type: none"> Backlight is too weak. 	<ol style="list-style-type: none"> Increase backlight setting.
<ol style="list-style-type: none"> Display backlight malfunctions. Display picture is faintly visible. 	<ol style="list-style-type: none"> Defective backlight tubes. Defective backlight power inverter. 	<ol style="list-style-type: none"> Replace tube assembly. Replace inverter PCB.
1. Rotary encoder malfunctions.	<ol style="list-style-type: none"> Defective encoder or interface. 	<ol style="list-style-type: none"> Replace keyboard PCB.
1. Panel buttons malfunctions.	<ol style="list-style-type: none"> Defective buttons or interface. One button stuck. 	<ol style="list-style-type: none"> Replace keyboard PCB. Check key switches or replace keyboard PCB.

Symptom	Cause	Remedy
Basic functionality		
1. No bottom detection or bottom contour.	<ol style="list-style-type: none"> Too low Gain setting. Too low TVG setting. Too low power setting. Wrong frequency selection. 	<ol style="list-style-type: none"> Adjust settings. Adjust settings. Adjust settings. Select correct frequency.
1. Bottom tracking is intermittent or erroneous.	<ol style="list-style-type: none"> Marginal gain, TVG or power settings. Weather conditions. Transducer installation faulty. Faulty dual transceiver PCB. 	<ol style="list-style-type: none"> Adjust settings. Try adjusting gain, TVG or power settings. Check transducer wiring. Change or check dual transceiver PCB.
1. Bottom tracking is masked by high noise levels.	<ol style="list-style-type: none"> Too high gain setting. Too high TVG setting. To high power setting. 	<ol style="list-style-type: none"> Adjust settings. Adjust settings. Adjust settings

Symptom	Cause	Remedy
NMEA and external interfaces.		
1. NMEA input signals are not listed on the NMEA screen 10.	<ol style="list-style-type: none"> Wrong polarity input signals. NMEA port, selected for observation is not correct. Wrong baud rate. RS-232 driver malfunction. NMEA driver malfunction. 	<ol style="list-style-type: none"> Swap NMEA input wires. Try to select another NMEA port on the NMEA screen. Select the same baud rate as the talker. Replace CPU PCB. Replace terminal PCB.
1. NMEA input signals are listed on the NMEA screen 10, but not accepted by the GDS102.	<ol style="list-style-type: none"> GDS102 initialization. Irregular message mnemonic. 	<ol style="list-style-type: none"> Cycle GDS102 power after NMEA connection is established. Check remote (talker) setup.
1. NMEA output signals are not accepted by the remote system.	<ol style="list-style-type: none"> Remote listener setup. 	<ol style="list-style-type: none"> Verify correct remote listener setup e.g. baud rate etc.
1. Analogue output malfunctions.	<ol style="list-style-type: none"> Incorrect analogue limits setting. Analogue circuitry malfunction. 	<ol style="list-style-type: none"> Verify upper and lower limits on screen 7. See “Fig. 2.8. Screen 7. Interface setup screen.” on page 19. Replace terminal PCB.
1. Remote sounding control inputs malfunction.	<ol style="list-style-type: none"> Incorrect polarity. Pulse input circuitry malfunction. 	<ol style="list-style-type: none"> Verify settings on screen 7. Replace terminal PCB.

6. User Maintenance

Transducer maintenance

The transducers are virtually maintenance free, but occasional cleaning may be necessary depending on sea water conditions and organic growing on ship's hull.

Operator Unit Maintenance

The operator unit contains no user serviceable parts, and requires no maintenance apart from occasional cleaning of the front panel. Please use a soft cloth and no chemicals except cleaning alcohol.

7. System Specifications

Functional Properties

Display	158 x 211 mm (10.4") TFT colour LCD screen with adjustable contrast and backlight. 640 x 480 pixels.
Printer	Optional external printer, HP Deskjet, Epson D88 or Epson LQ 300.
Depth alarms	Deep and shallow limits.
Calendar/Clock	Year-month-day/hours-minutes (24 hour system).
Interface outputs	<ul style="list-style-type: none"> • Trigger and bottom pulses. • Analogue 4 - 20 mA and 0 - 10 V for depth. • NMEA 0183. • Alarm relay. • Output for VGA repeater. • PC parallel printer port.
Interface inputs	<ul style="list-style-type: none"> • NMEA 0183 for speed, position, heading and time. • External alarm reset
Languages	<ul style="list-style-type: none"> • English. • French. • Spanish. • German. • Norwegian.
Options	<ul style="list-style-type: none"> • IR301 digital remote depth indicator. • LCD repeater. • Remote keyboard. • Remote sounding control (GDS102S). • Reduced power output. • Sound speed calibration (GDS102S).

Performance

Displayable depth range	0 - 5000 m	
Graphic resolution	0.5 % of range	
Digital screen resolution	< 10 m: 0.01 m >= 10 m < 100 m: 0.1 m >= 100 m: 1 m	
Transducer, 24 kHz/38 kHz	Beam angle	16°/20° conical.
	Max. power	1 kW.
	Effective range	3000 m/1500 m.
Transducer, 50 kHz	Beam angle	33° conical.
	Max. power	1 kW.
	Effective range	750 m.
Transducer, 200 kHz	Beam angle	6°/10° conical.
	Max. power	1 kW.
	Effective range	350 m/350 m

Environmental according to IEC 60945:**Transducer and Junction Box**

Operating temperature	-15 to +55 degrees C.
Storage temperature	-20 to +70 degrees C.
Protection, transducer	6 bar.
Protection, junction box	IP 56.

Operator Unit Cabinet

Supply voltage	115 V AC (96 to 125 V), 230 V AC (195 to 253 V). 24V DC (20 to 32 V). (Automatic switch over).
Power consumption	App. 60 W at 24 V, App. 80 W at 115 V or 230 V.
Alarm relay	Change-over contact, max. 24 V 300 mA.
Printer	25 pin D-type connector, (female).
NMEA port	9 pin D-type connector, (female). 2 Inputs, 2 Outputs.
Operating temperature	-15 to +55 degrees C. (To increase serviceability and life-time, we suggest the working temperature to be held at 0 to +40 degrees C).
Storage temperature	-20 to +70 degrees C.
Humidity	10 to 90 % relative, no condensation.
Protection	IP 42.
Measuring accuracy	Better than 1 %.

Dimensions

Transducer, 24 kHz/38 kHz	Diameter	181 mm.
	Mounting	Tank/sea valve/ice tank.
	Cable length	40 m.
	Weight	app. 20 kg.
	Protection	IP 68.
Transducer, 50 kHz	Diameter	90 mm.
	Mounting	Tank/sea valve/ice tank.
	Cable length	25 m or 40 m.
	Weight	app. 7 kg.
	Protection	IP 68.
Transducer, 200 kHz	Diameter	140 mm.
	Mounting	Tank.
	Cable length	25 m or 40 m.
	Weight	app. 8 kg.
	Protection	IP 68.
Transducer, 200 kHz	Diameter	90 mm.
	Mounting	Sea valve/tank/ice tank.
	Cable length	25 m.
	Weight	app. 7 kg.
	Protection	IP 68.
Transducer Junction Box	Size incl. glands	132 x 111 mm.
	Depth	55 mm.
	Weight	0.6 kg.
	Protection	IP 56.
Operator unit cabinet	Height, front	340 mm.
	Width	320 mm.
	Depth	170 mm.
	Weight	app. 10 kg.
	Protection	IP 23.

8. Service

All service requests should be made to the local SKIPPER representative. Adjustments and repairs should only be performed by qualified service engineers. Unqualified repair attempts will void the warranty.

CPU 6742VE Setup

In some cases support engineers may ask for the CPU setup configurations. To access these, a normal PC keyboard (PS/2) is required and the following steps should be taken:

1. Connect a PC keyboard to the CPU board.
2. Connect a VGA screen to the CPU board.
3. Switch the GDS102 power switch “ON” while pressing the “DELETE” key on the PC keyboard.
4. Do not release “DELETE” key until several clicks, beeps and signals have been heard, and picture is present on the VGA screen. Then release key.

This board has the following BIOS settings (BIOS version 1.12). The PCA 6742VE has the default settings with the following changes. Start by loading the optimized defaults, and then change the following:

CPU SETUP:

STANDARD CMOS FEATURES

Date	Change to todays date
Time	Change to time now
HALT ON	NO ERRORS

Advanced BIOS Features

- a. Hard Disk priority [Press enter] – Press enter
 - i. 1 should be ch.1 M.
 - ii. 2 should be ch 0 M.
- b. First Boot Device [Hard Disk]
- c. Second Boot Device [Hard Disk]
- d. Boot other device [Disabled]

Advanced Chipset features

- a. SMI712 VGA Settings [Press Enter] – Press enter
 - i. SMI712 VGA Monitor [Simul monitor]
 - ii. Panel resolution Mode [640 x 480 TFT]
- b. USB Device Setting [Press Enter] – press enter
 - i. USB1.0 emulation [Disabled]

Integral Peripherals

- a. Onboard serial Port 3 [enter]
 - i. Change to [2E8/IRQ9]
- b. Onboard serial Port 4 [enter]
 - i. Change to [3E8/IRQ5]
- c. Parallel Port Mode [EPP]
- d. EPP Mode Select [EPP1.9]

PnP/PCI Configurations

- a. Resources Controlled By [Manual]
- b. IRQ Resources [Enter]
 - i. IRQ – 7 assigned to [Legacy ISA]
 - ii. IRQ – 10 assigned to [Legacy ISA]
 - iii. IRQ – 11 assigned to [Legacy ISA]
- c. NO DMA

PC Health Status

- a. Case Open Warning [Disabled]

SAVE SETTINGS AND EXIT

Master Reset Procedure

After completed set-up procedure, you should always do a ‘‘Master Reset’’:

- Switch off the GDS102 using the internal toggle switch and wait a few seconds.
- Then press down and keep pressed the soft key to the far left and far right (no. 1 and 6) in the upper row on the GDS102 keyboard.
- Turn ‘‘on’’ the GDS102, and keep the two soft keys pressed down until the screen shows the normal picture. This may take as long as app. 30 seconds.
- You should now normally hear 4 ‘‘beeps’’.

You have now completed the ‘‘Master Reset’’ procedure.

Upgrading Software

New software versions are released from time to time. The GDS102 with Compact Flash (CF) can be updated by performing the following software upgrade procedure.

1. If you have received a programmed compact flash, skip stage 2.
2. Newest software may be downloaded from the web <http://www.skipper-service.no/skipdoc/skipdoc.php>. Under ‘‘software’’ you will find your equipment type. Also copy the latest version of startup.exe into the root folder.

Note: Standard Compact Flash reader is needed to be attached to the PC.

Note: It is possible to use the Compact Flash card, which is already installed in the display unit.

3. Switch ‘‘off’’ the mains of the display unit and insert Compact Flash card with the new software on it.
4. Press the ‘‘hidden’’ button inside the cabinet (mounted on the solder side of the keyboard). Keeping the ‘‘hidden’’ button pressed, switch ‘‘on’’ the mains in the display unit and keep the button pressed while the message ‘‘You may release the upgrade button’’ appears in the lower part of the screen. If a new setup.exe is to be loaded, follow the on screen instructions.
5. Release the ‘‘hidden’’ button. After few diagnostic text messages, the list of available software versions will appear in the lower part of the screen as in example below.
6. Note: If the bootloader does not find any file with the software on the Compact Flash, the presently installed version will start automatically. In this case, make sure, that the upgrade and setup file has been copied correctly on the Compact Flash and repeat procedure.

1.12.7	1.12.6
External	Active

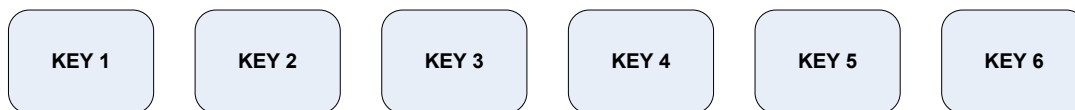

7. Select a software version, which you would like to install. Normally, it is possible to chose one out of two: the version, which is currently installed in the internal memory (indicated as Active) and the upgrade version (indicated as External). The version name is displayed in the upper line of the text lines, located just above the corresponding soft key. In the example above, soft key #1 should be pressed to select the latest software version.
8. Confirm selection by pressing YES button (or go back to selection, pressing NO).
9. Press any button to start the upgraded software (or it will start automatically in 5 seconds).
10. Note: The file with a previous software version will be copied back to the Compact Flash card, so it would be possible to re-install it in the similar manner, if desired.

Note: Always turn off the unit with the switch on the Combo Terminal board when removing/replacing the CF disk

9. EMC MOUNTING KIT

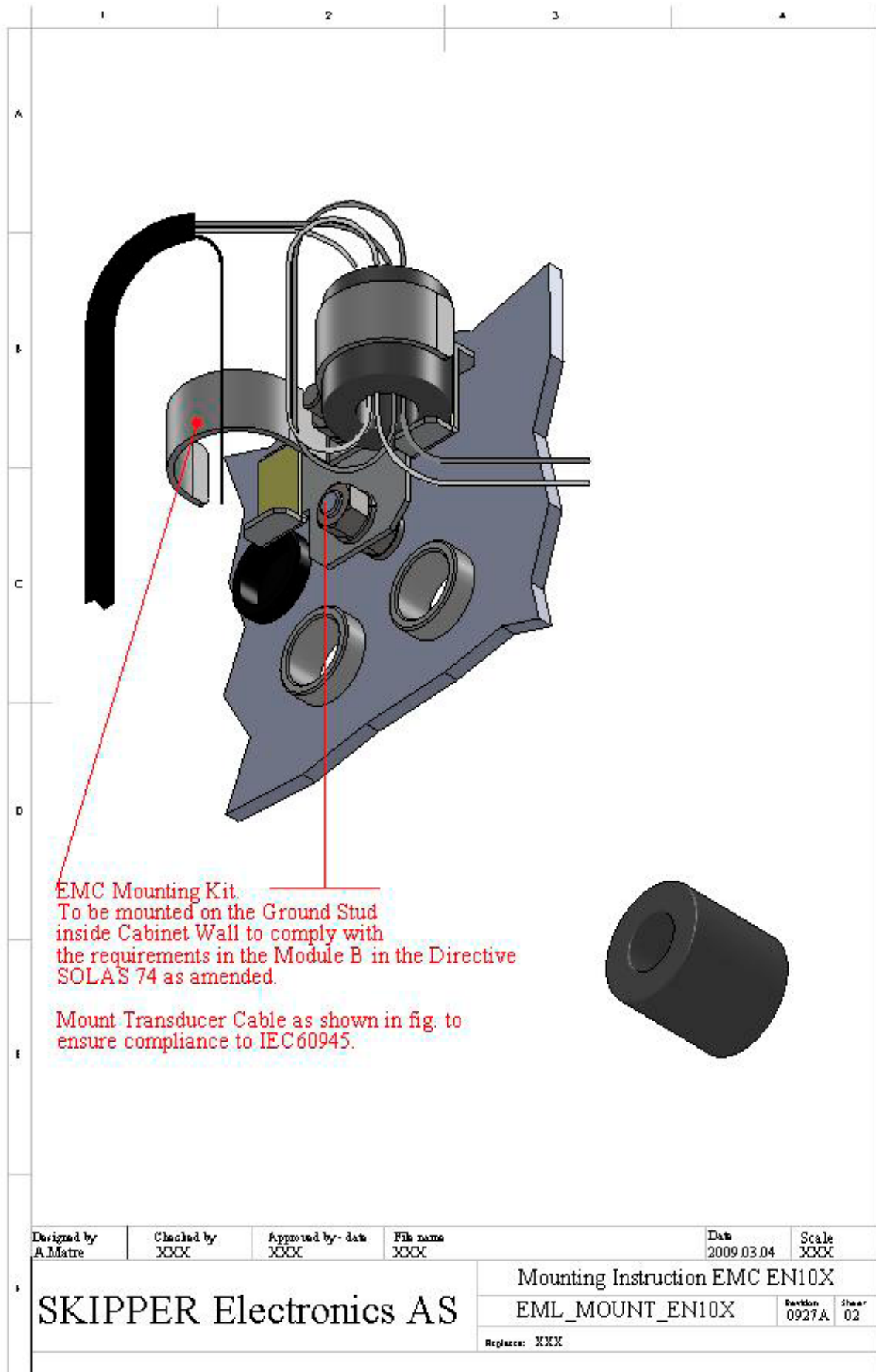

10. Warranty and Utilization

Warranty:

- SKIPPER Electronics AS gives 12 months limited guarantee on all deliveries from SKIPPER Electronics AS, Norway.
- Please note that if the equipment is delivered by a third party, the third party's warranty conditions may apply.
- All warranty request should be sent to the local supplier of the equipment.

Utilization:

- This equipment is not to be disposed in normal waste, but be handled in accordance with applicable waste disposal regulations in the country where the equipment is used.

12. Index

Symbols

115/230 V selection on Combo Terminal board inside Display Unit 34

A

Additional Features 9
 ALARM ▲ 13
 ALARM ▼ 13
 ALARM ID 19
 Alarm limits and local alarm buzzer control 47
 Alarm relay 40
 Alarms 9
 Alarm settings and acknowledgment 29
 Analogue interfaces 40
 Analogue Outputs Range Selection 47
 ANA LOWER 19
 ANA UPPER 19
 AUDIO ALARM 23
 Auto Range 9

B

Back-up battery jumper JP200 39
 Basic Algorithm Considerations 30
 Basic functionality 61
 Basic system integrity 61
 BAUD 22
 Bottom detection 30
 Brightness 7, 26
 Brightness (backlight) adjustment 27

C

Calibration, sound speed 57
 CLEANUP 21
 Clock and calendar settings 47
 Clock and Calendar Settings 29
 Continuous 57
 CPU 6742VE Setup 68
 CPU SETUP 68

D

Data Logging (Recordings Memory) 29
 Data type 30
 DATA TYPE 21
 DAY 17
 Day/Night 7, 26, 27
 DEPTH 18
 depth range 7, 26
 DIGIT 14
 Digital indication 27
 Dimensions 66
 DISPLAY 14, 22
 DRAUGHT 15
 Draught and Offset 27
 Draught indication 12

Dual transducer location (fore/aft) 31
 Dual transducer installation(fore/fore) 32

E

Edge 57
 EMC 42
 EMC mounting kit 70
 ENABLE 19
 Encoder 7, 26
 Environmental according to IEC 60945: 65
 Example of parameter entry 11
 External alarm reset input 41
 External Interface Ports 37
 External Printer 9
 External printer connection 41
 External Printer Operation 28

F

Fig. 1.1 Operator Unit Panel Layout 7
 Fig. 1.2. System Diagram 8
 Fig. 2.1. Setting and Parameter Entry Flowchart 11
 Fig. 2.2. Screen 1. Gain, TVG and alarm settings. 13
 Fig. 2.3. Screen 2. Display and print settings. 14
 Fig. 2.4. Screen 3. Power adjustment and options. 15
 Fig. 2.5. Screen 4. Transducer details. 16
 Fig. 2.6. Screen 5. Calendar and clock setting. 17
 Fig. 2.7. Screen 6. Units of measurement. 18
 Fig. 2.8. Screen 7. Interface setup screen. 19
 Fig. 2.9. Screen 8. Recordings selection and play back. 20
 Fig. 2.10. Screen 9. Recordings options. 21
 Fig. 2.11. Screen 10. NMEA control screen. 22
 Fig. 2.12. Screen 11. System status screen. 23
 Fig. 2.13. Screen 12. Oscilloscope screen. 24
 Fig. 3.1. Basic System Configuration. 32
 Fig. 3.2. Transducer junction box. 33
 Fig. 3.4. AC Voltage selection and fuses. 36
 Fig. 3.5. Data Communication Interfaces. 37
 Fig. 3.6. Data Communication Interfaces. 38
 Fig. 3.7. Back-up battery jumper JP200, on I/O board. 39
 Fig. 3.8. Terminal board connections 43
 Fig. 3.9. Input/Output Circuitry 1 44
 Fig. 3.10. Input/Output Circuitry 2 45
 Fig. 3.11. Input/Output Circuitry 3 46
 Fig. 4.1. nmea connector XJ402. 49
 Fig. 4.2. Frequency settings 50
 Fig. 4.3. SW1 bandwidth settings 50
 Fig. 5.1. Function LEDs, on terminal board. 59
 Filter setup 50
 Fixed keys 7
 Frequency 27
 FREQUENCY 16
 Frequency setup 50
 Functional Properties 64
 Function LEDs. 59
 Fuses 36

- G**
GAIN 13, 25
Gain and TVG (Time Variable Gain) 27
Graphics 7, 26
- H**
Heading indication from GPS 12
High voltage measurement. 58
HOURS 17
- I**
Important 34, 39, 42, 50
Index 73
Input/Output Circuitry 1 44
Input/Output Circuitry 2 45
Input/Output Circuitry 3 46
Inputs 9
Installation 31
Installation Details 32
Interfacing 9, 40
Introduction 6
- L**
LANGUAGE 18
Language and Units of Measurement 48
Level 57
LOCATION 16
- M**
Manual 57
MARK 13
Master Reset Procedure 69
MAX RANGE 19
MESSAGE 22
MINUTES 17
- N**
NMEA and external interfaces. 62
NMEA interface 40
NMEA PORT 22
NMEA received/input messages 49
NMEA Setup 48
NMEA transmitted/output messages 48
Nonvolatile Parameter Memory. 30
Note 12, 14, 17, 22, 23, 28, 29, 40, 41, 48, 57, 58
Notes 73
- O**
OFFSET 25
Operation 11
Operation Screens 12
Operator Panel and Data Entry 6
Operator Unit Cabinet 65
Operator Unit Installation 34
Operator Unit Maintenance 63
Options 9, 41, 57
Optocoupler 2 output 42
Oscilloscope Screen 30
Output Power 27
Outputs 9
- P**
Parameter entry 11
Performance 64
Picture speed 7, 26
Ping 57
PING 15
Ping to Ping filtering 30
PLAY BACK 20
Position from GPS 12
POWER 15, 25
PRIMARY 16
Primary channel assignment 47
Primary channel indication 12
Primary Operation Screens (screen 1 - 3) 13
Primary/Secondary Channels Concept 6
Principal Functions. 26
PRINT 14
PRINT TYPE 23
PULSE 19
- R**
RANGE 15
RECALL 23
REC. HOUR 20
REC. MIN 20
Recorded Data Storage 7
RECORDING 20
Remote Keyboard 42
Remote Sounding Control 10, 42, 57
Repeaters/Slaves 9, 41
- S**
SCREEN 14, 21, 22, 23, 25
SCREEN POS 16
Screen presentation 47
Screen select 7, 26, 27
Secondary Operation Screens (screen 4 - 12) 16
SELECT 20
SELECT CHN 13, 15, 16, 25
Service 67
SIMULATE 23
Simulator 30
Single transducer location 31
Soft keys 7, 26
Soft key texts 7, 26
SOUND 15
SOUND SPD 18
Sound Speed Calibration 10
Speed indication from GPS 12
Standard System Supply 31
Start-up and system Adaption 47

STATUS 22
Status Screen 30
Status Screen (screen 11) diagnosis 58
STORE 23
SYSTEM 14
System Adaptation 47
System ON/OFF 29
System Specifications 64
System Summary 6

T

Terminal board connections 43
Time indication manual or from GPS 12
Transducer and Junction Box 65
Transducer Installation 31
Transducer installation position 47
Transducer Junction Box. 33
Transducer maintenance 63
Transducers 6
Transmitter trigger pulse and bottom pulse outputs 41
Trouble shooting 58
TVG 13, 25
Typical Status Screen 11 Contents 60

U

Upgrading Software 69
User Maintenance 63
Utilization 71

V

VESSEL SPD 18
Voltage selection connectors and fuses, Terminal Board 36

W

Warning 7, 17
Warranty 71

Y

YR.MONTH 17